

# STRUCTURAL AMBIGUITY IN THE VIETNAMESE RELATIVE CLAUSE

Carolyn P. Miller

1. Introduction
2. Base Component
3. Relative Clause Ambiguity
4. Ambiguity With Other Constructions
5. Summary

1. Introduction. The purpose of this paper is to demonstrate how the relationships between the relative clause in Vietnamese and certain constructions structurally ambiguous with it may be described in terms of their underlying or deep structure. A secondary purpose is to show that these subordinate constructions can be profitably described in terms of the transformational-generative method of embedding.<sup>1</sup>

Both Liêm (1966) and Cadière (1958) refer to Vietnamese as being governed by certain "laws". In his preface, Liêm states (1966:xvi):

Vietnamese is an uninflectional and, at least phonologically speaking, monosyllabic language. That means that there are only two syntactic and morphological devices in Vietnamese: the use of word order, and the use of function words.

This limited number of grammatical devices in Vietnamese is closely related to and characteristic of the Vietnamese

linguistic behaviour, which would seem to be governed by two behavioural laws: the law of indeterminacy; and the law of simplicity.

Liêm's reference to the "law of indeterminacy" and his subsequent illustration of it are reminiscent of what Cadière also affirmed as the "loi d'indétermination" for Vietnamese. Liêm cites (1966: xvii) as an example of this law the fact that the sentence, nó về tôi về + falling intonation, "can be understood he return I return in different ways according to the larger linguistic matrices." It could be understood to mean variously:

If he goes home, I'll go home too.

When he goes home, I'll go home too.

Every time he goes home, I go home too.

Because he is going home, I am going home too.

Because he went home, I went home too.

Since he might be going home, I am going home now, etc.

The term "law of indeterminacy" suggests imprecision and raises the question whether the syntactic patterns of Vietnamese can be described in a formal way, particularly in areas where ambiguity exists. We wish to show in this paper that by distinguishing underlying from surface structure following Chomsky (1965), it can be shown how various ambiguous readings relate to each other in terms of their unambiguous underlying structures. It can also be shown how these unambiguous underlying structures converge to become ambiguous through the application of certain transformations.

Liêm observes that Vietnamese employs only word order and function words to indicate its grammatical patterns. What makes this situation of particular interest is the fact that the function words may frequently be deleted and the word order changed with a resulting structural ambiguity. Transformational theory affirms that a native hearer, however, understands an utterance because he is able to relate the utterance to its proper underlying representation. In other words, he is able in terms of the context to replace the deleted grammatical function words and make adjustments of word order.

It should be noted that a hearer is usually unaware that ambiguity exists since he understands only the meaning which the context suggests. Or, he may not realize that some sentences are ambiguous because one of the possible readings is false or anomalous.

Another law which is said to govern Vietnamese is called by Liêm the "law of simplicity" and by Cadière the "loi de succession". "The Vietnamese language," Liêm states (1966:xviii), "is said to be

governed by the law of simplicity in the sense it tends to use simple constructions, and compound constructions, rather than to use complex constructions."

In illustration of this, sentence 1) below is said by Liêm to be composed of two coordinate parts joined loosely by an "Independent Clause Coordinator," thì.

1) Nó về nhà thì (nó) gặp một người khách  
 he return house he meet one person visitor  
 (When he returned home, he met a visitor.)

In contrast to this, sentence 2) would be said to be complex because the first phrase is introduced by an "Extra Dependent Introducer," khi.

2) Khi nó về nhà thì (nó) gặp một người khách  
 when he return house he meet one person visitor  
 (When he returned home, he met a visitor.)

Several problems are apparent in this treatment. First, if thì is an "Independent Clause Coordinator," its presence in the second sentence is anomalous. Second, as the translations given for the two sentences indicate, the meaning of the sentences is identical. That is, whatever relationship exists between the two parts in the second sentence also exists in the first. Third, the first sentence could be ambiguously understood to mean also 'If he returns (returned ...); 'Since he returns (returned)...'; 'Because he returns (returned)...'; etc. So that it would seem to be helpful to be able to treat both sentences in the same way and to speak of the first as having the introducer deleted. It is the purpose of this paper to show that treating these subordinate constructions as embedded sentences in underlying structure results in a more satisfactory description of their relationship to the main clause or matrix sentence.

2. Base Component. This section will present rules for generating sentences in Vietnamese. The rules are not complete in that they will not generate all possible sentences in Vietnamese. They are, however, the rules necessary to produce the kinds of sentences discussed in this paper. Following them, some subcategories of grammatical classes will be noted.

1-- #S# → NP + PP

The sentence (#S#) in Vietnamese is said to be composed of an obligatory noun phrase (NP) and an obligatory predicate phrase (PP). The noun phrase subject very frequently is deleted in surface structure, but it is always present in underlying structure.<sup>2</sup>

2-- PP → (Cond) (Caus) (tns) VP (T) (L)<sup>3</sup>

The predicate phrase (PP) consists of the verb phrase (VP) and

those optional elements which, although they seem to be in some way related to the verb, do not subcategorize the verb in any way. These elements are condition (Cond), cause (Caus), tense (tns), time (T), and location (L). An example of sentences containing all elements of the predicate phrase is:

Nếu mà chúng tôi hết bánh mì  
 if we all gone bread  
tôi sẽ mua ở bên chợ ngày mai bởi vì có khách  
 I fut. buy at beside market tomorrow because have company  
đến. 'If we are out of bread, I will buy some at the market to-

come tomorrow because company is coming.'

3-- VP → { V ( (cho) NP) (NP) (Man) {Purp }  
 {Vb Comp} }  
 là + NP

One kind of verb phrase consists of an obligatory verb (V) with all other elements optional. These optional elements include a noun phrase indirect object which may or may not be preceded by cho, a noun phrase direct object, manner (Man), and either purpose (Purp) or verbal complement (Vb Comp). The other kind of verb phrase, which is equational in nature, consists of là plus a noun phrase.<sup>4</sup> The following sentences illustrate the verb phrase first with purpose, then with verbal complement, then with là plus noun phrase:

Tôi sẽ sẵn lòng đưa con cái áo để mà con đi  
 I will willingly give child Cl. dress so that child go

học không trễ.  
 study not late 'I will willingly give you your dress so you won't be late to school.'

Tôi hân hạnh để mà thấy ông.  
 I happy to see grandfather 'I am happy to see you.'

Ông ấy là bác-sĩ.  
 grandfather that is doctor 'That man is a doctor.'

4-- Cond → nếu mà + #S#

5-- Caus → bởi vì + #S#

Condition (Cond) is composed of nếu mà plus a sentence and Cause (Caus) of bởi vì plus a sentence.

Nếu mà anh tôi đi lính (thì) mẹ tôi sẽ khóc.  
 if older brother my go soldier mother my will cry  
 'If my older brother goes into the army, my mother will cry.'

Bởi vì người ta nói không thật (thì) tôi không tin.  
 because they speak not true I not believe

'Because they don't tell the truth, I don't believe them.'

6-- NP  $\longrightarrow$   $\left\{ \begin{array}{l} \text{(Nu) (Cl) N (dem) (\#S\#)} \\ \text{pro} \\ \text{\#S\#} \end{array} \right\}$

The noun phrase consists, in one form, of an obligatory noun preceded by an optional numeral (Nu) and/or classifier (Cl) and followed by an optional demonstrative (dem) and/or sentence. It may, in other forms, be composed of a pronoun (pro) or a sentence in factive construction.

Những người cảnh sắt đó người mà đã giúp tôi  
Plural Cl. policeman dem Cl past help me

(thì) siêng lắm.  
hardworking very

'Those policemen who helped me are very hardworking.'

Nó cũng ăn xoài.  
they also eat mango

'They also eat mangos.'

Ông ấy thương con  $\left\{ \begin{array}{l} \text{là} \\ \text{thì} \end{array} \right\}$  dễ hiểu.  
grandfather dem love child easy understand

'That that man loves his child is easy to understand.'

The major categories in Vietnamese, that is, nouns and verbs, may be said to comprise smaller subcategories. Nouns are subcategorized according to the classifiers they accept or by their refusal to accept classifiers (see Hòa 1957).

Verbs are subcategorized in a number of ways. They may be subcategorized as to those which take an object (such as mua 'to buy'); those which do not take an object (such as ngủ 'to sleep'); and those which may either accept or refuse an object (such as làm 'to make, to work'). Those which take an object are further subcategorized as to those which may take an indirect object (such as đưa 'to give'); and those which may not take an indirect object (such as thấy 'to see').

In addition to their ability to occur with direct and indirect objects, verbs are subcategorized by the other elements within the verb phrase. There are those which take verbal complement but not purpose (such as ngạc nhiên 'to be surprised'); those which take purpose but not verbal complement (such as cho 'to give'); and a few which may take either purpose or verbal complement (such as trễ 'to be late'). They are also subcategorized according to whether they can take manner (as, for example, đi 'to go'); or cannot take manner (as, for example, vui 'to be happy'). Of those which do not take manner, some may take a factive construction (such as tốt 'to be good') while others may not (such as đẹp 'to be beautiful').<sup>5</sup>

3. Relative Clause Ambiguity. The relative clause in Vietnamese may be defined as a sentence embedded within the noun phrase. That is, its presence is manifested in deep structure by the inclusion of the optional element (#S#) in the rule  $NP \rightarrow (Nu) (Cl) N (dem) (\#S\#)$ . Embedding may occur in any position where the NP may occur (i.e. subject, direct object, indirect object, etc.). The only condition required for embedding is that a noun in the matrix sentence be held in common with a noun in the embedded sentence.

To illustrate the way in which relative clause formation is accounted for here, we will give a representation of the deep structures of sentences 1) and 2) below and will use these deep structures to illustrate various possibilities for the embedding of the relative clause.

- 1)  $\frac{\text{Đứa}}{\text{Cl}} \quad \frac{\text{con}}{\text{child}} \quad \frac{\text{khóc.}}{\text{cry}}$       'The child is crying.'
- 2)  $\frac{\text{Đứa}}{\text{Cl}} \quad \frac{\text{con}}{\text{child}} \quad \frac{\text{trễ.}}{\text{late}}$       'The child is late.'

Underlying Tree A: Sentence 1)

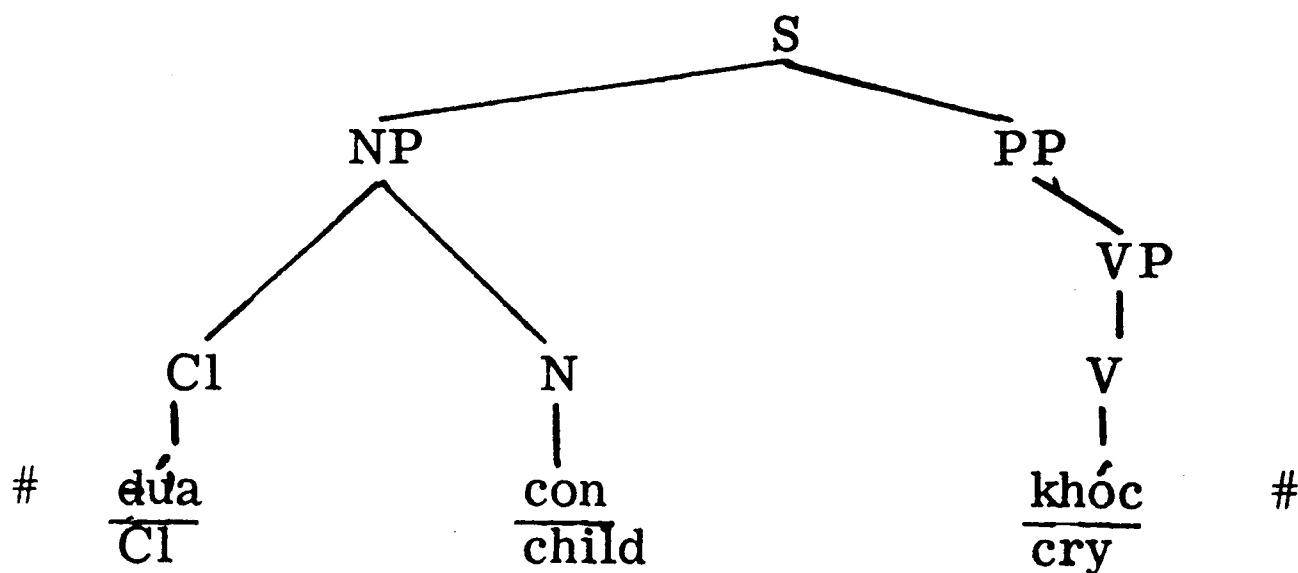

'The child is crying.'

Underlying Tree B: Sentence 2)

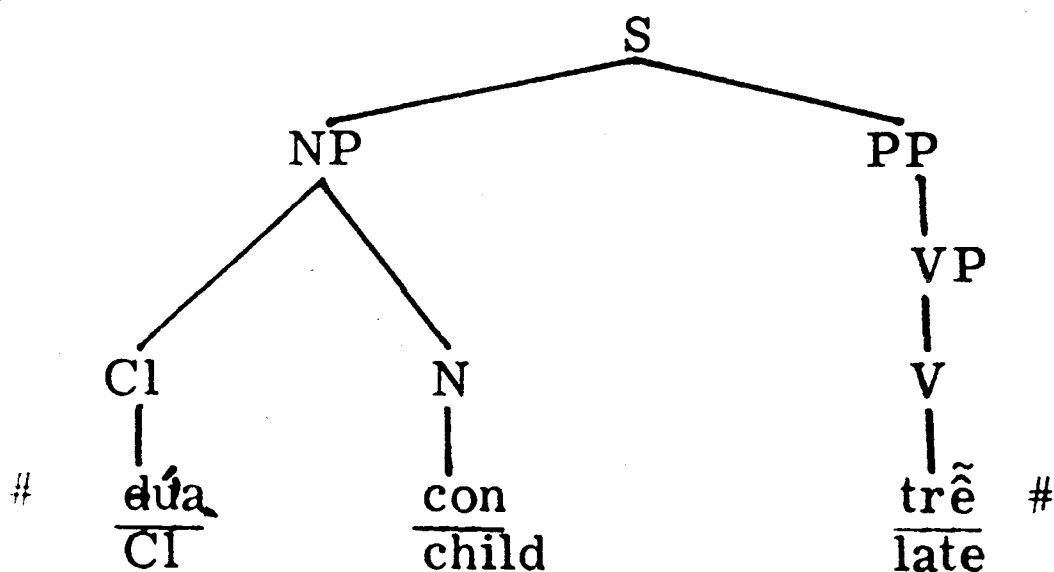

'The child is late.'

Underlying Tree C: Embedding of 2) into 1)

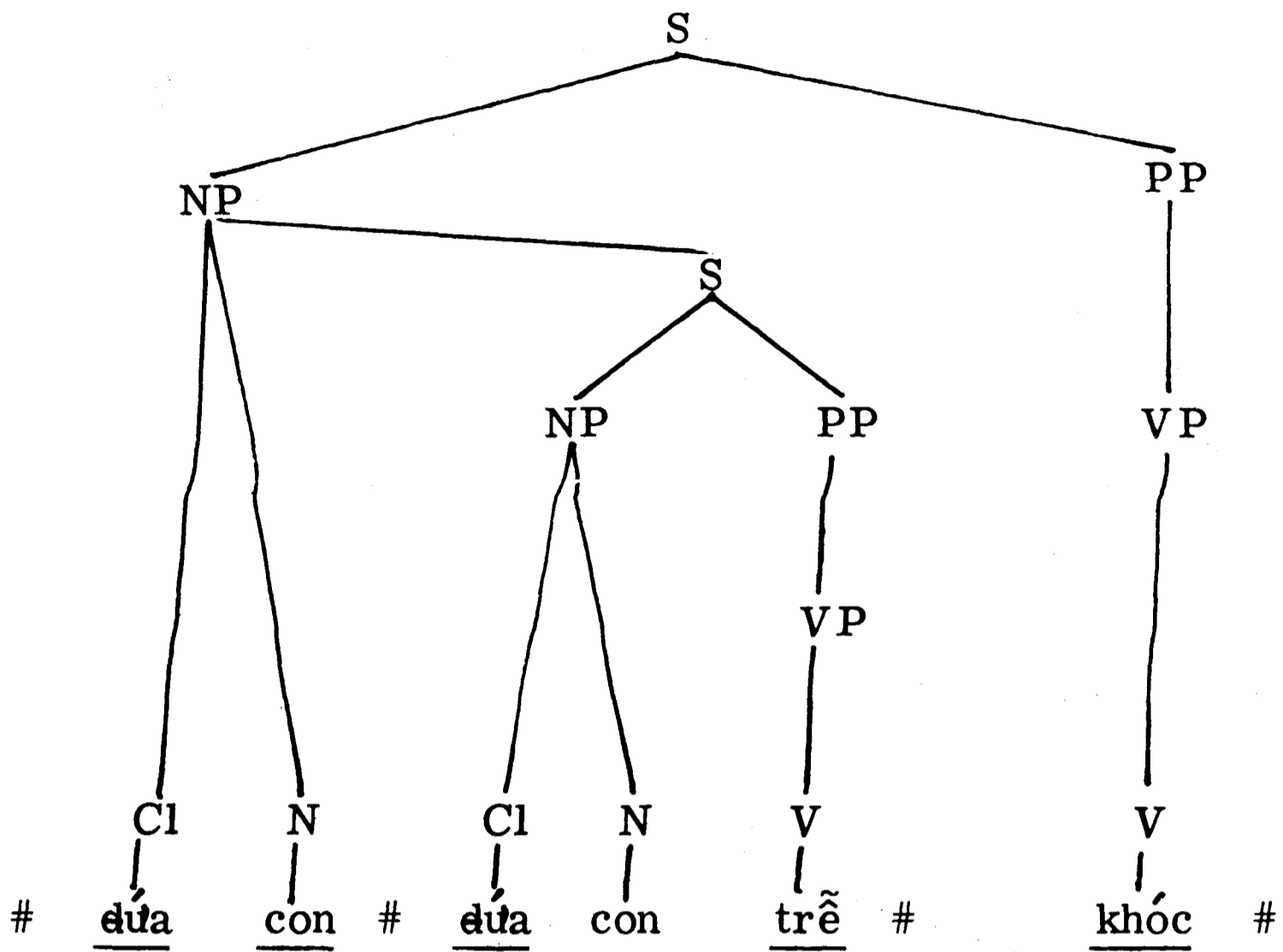

'The child who is late is crying.'

Underlying Tree D: Embedding of 1) into 2)

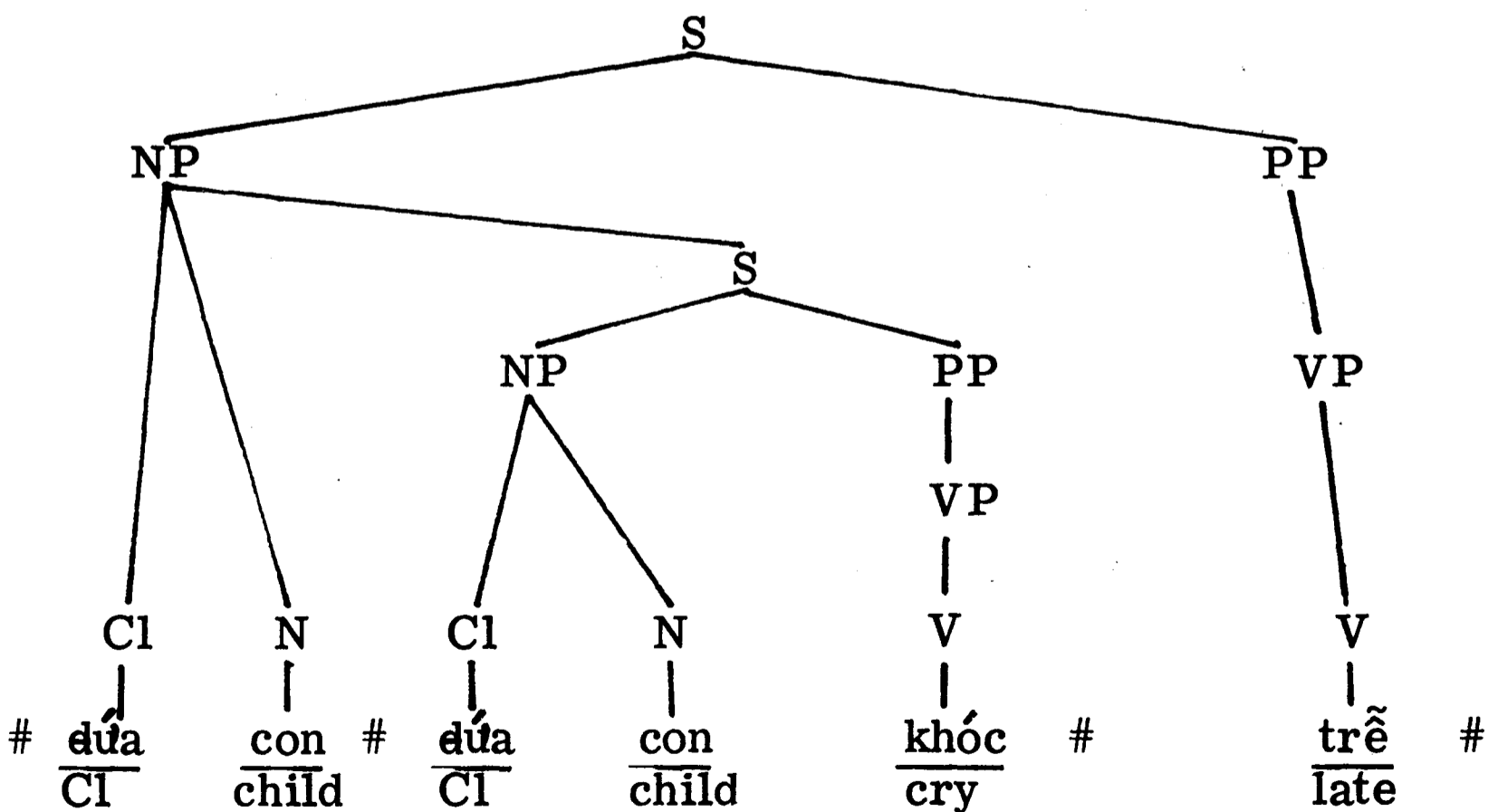

'The child who is crying is late.'

The preceding trees illustrate how two sentences can be embedded when the noun subject of the intransitive verb sentence is shared by the noun subject of the stative verb sentence. The same operation may also be performed with other types of sentences in which shared nouns are not in subject position. Example 3) below has a subject noun which is identical to the indirect object noun of example 4). Trees G and H below indicate how each of these sentences may be embedded as a relative clause within the other.

3) Đứa con là người học sinh. 'The child is a student.'  
 CI child is CI student

4) Tôi sẽ cho đứa con một cái áo.  
 I fut give CI child one CI dress

'I will give the child a dress.'

Underlying Tree E: Sentence 3)

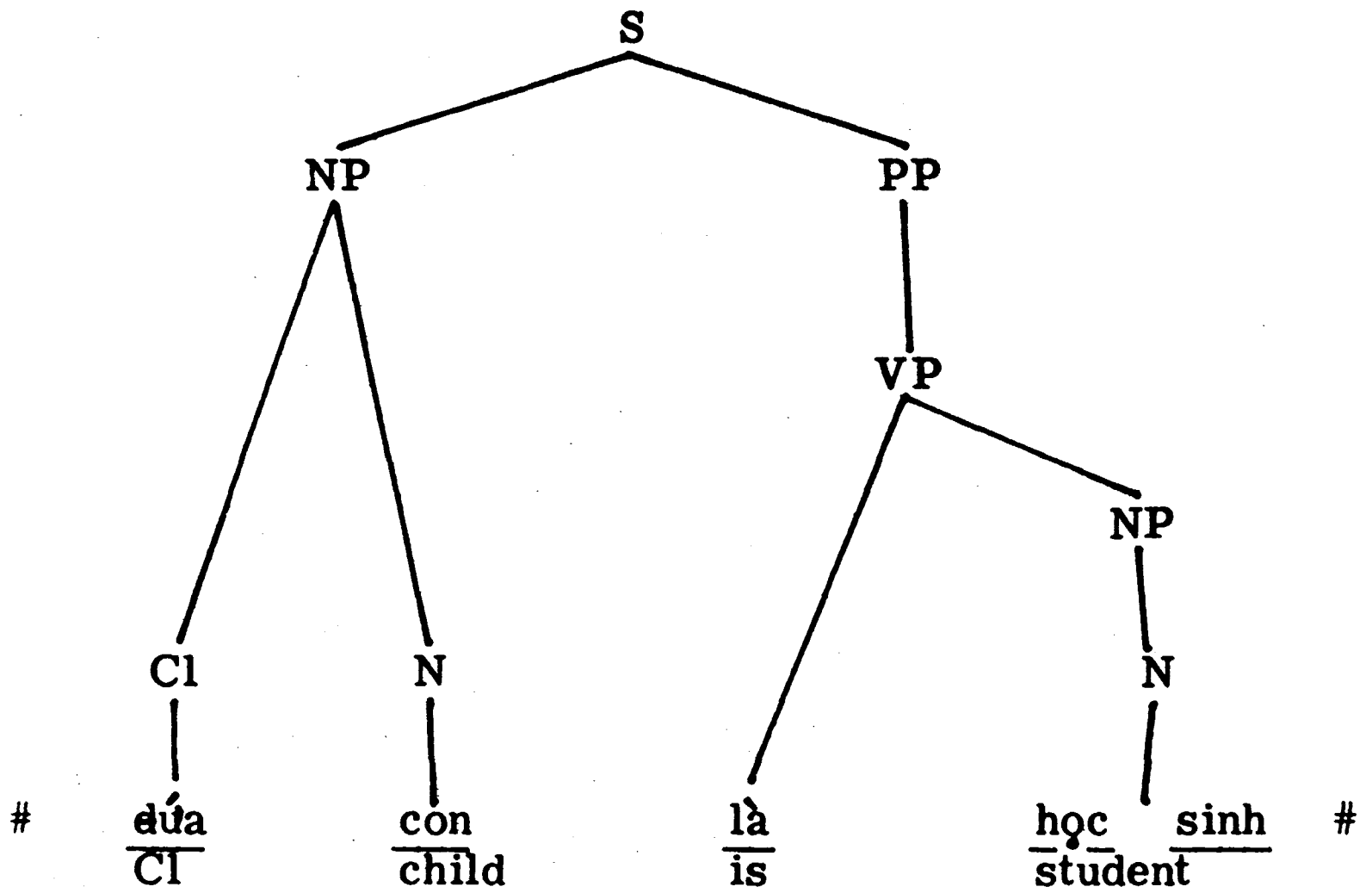

'The child is a student.'



Underlying Tree F: Sentence 4)

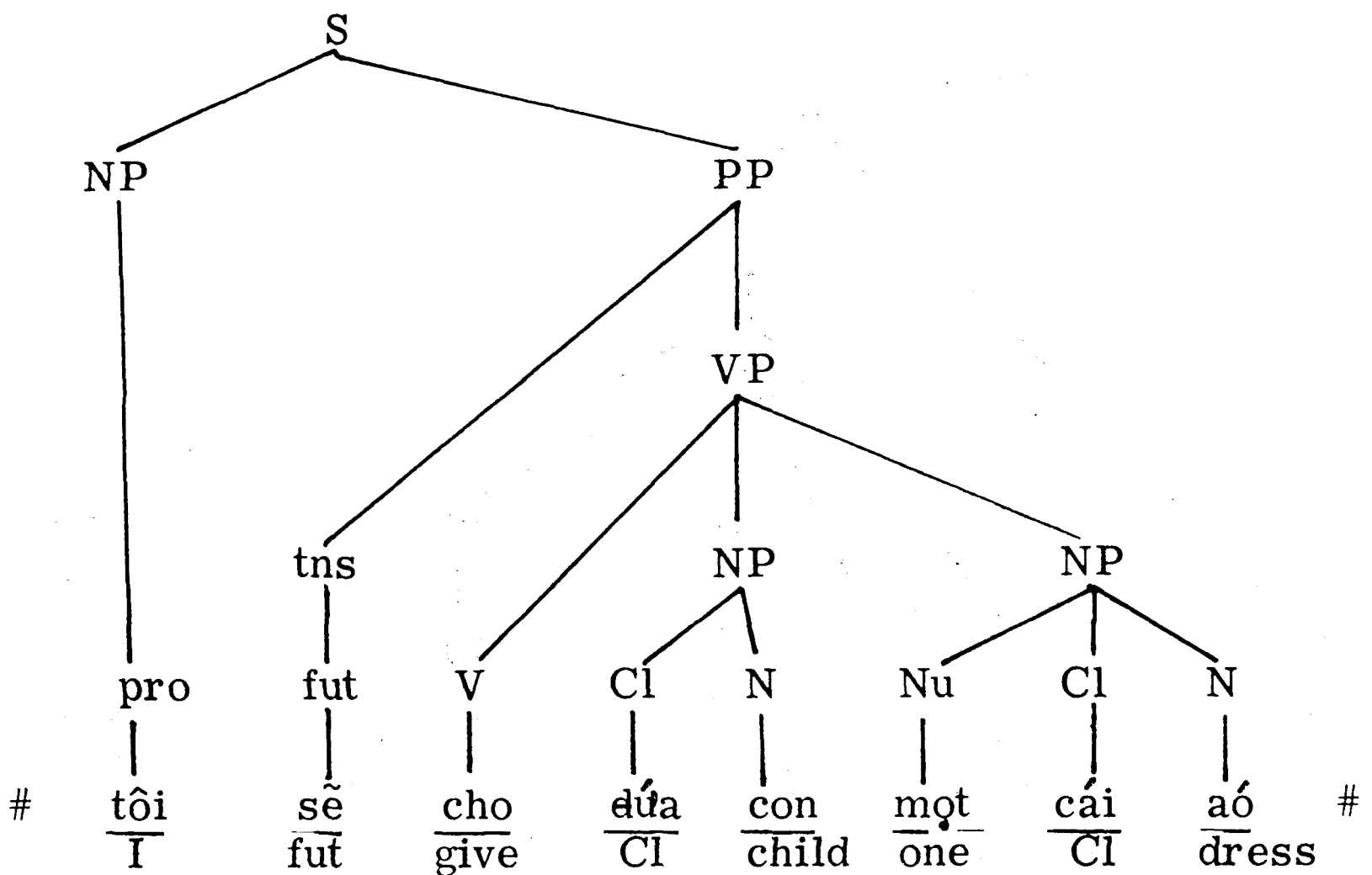

'I will give the child a dress.'

Underlying Tree G: Embedding of 4) into 3)

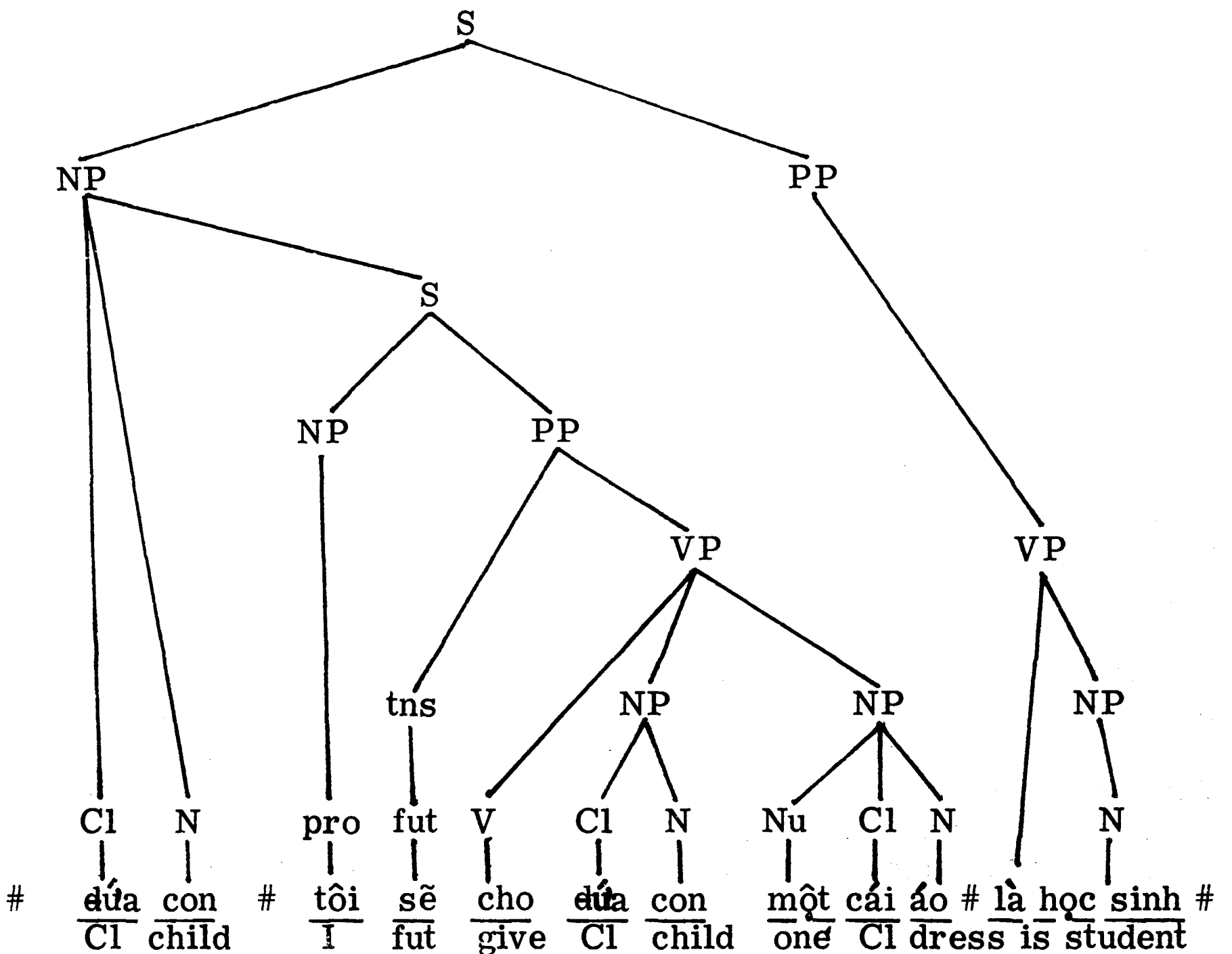

'The child to whom I will give a dress is a student.'

## Underlying Tree H: Embedding of 3) into 4)

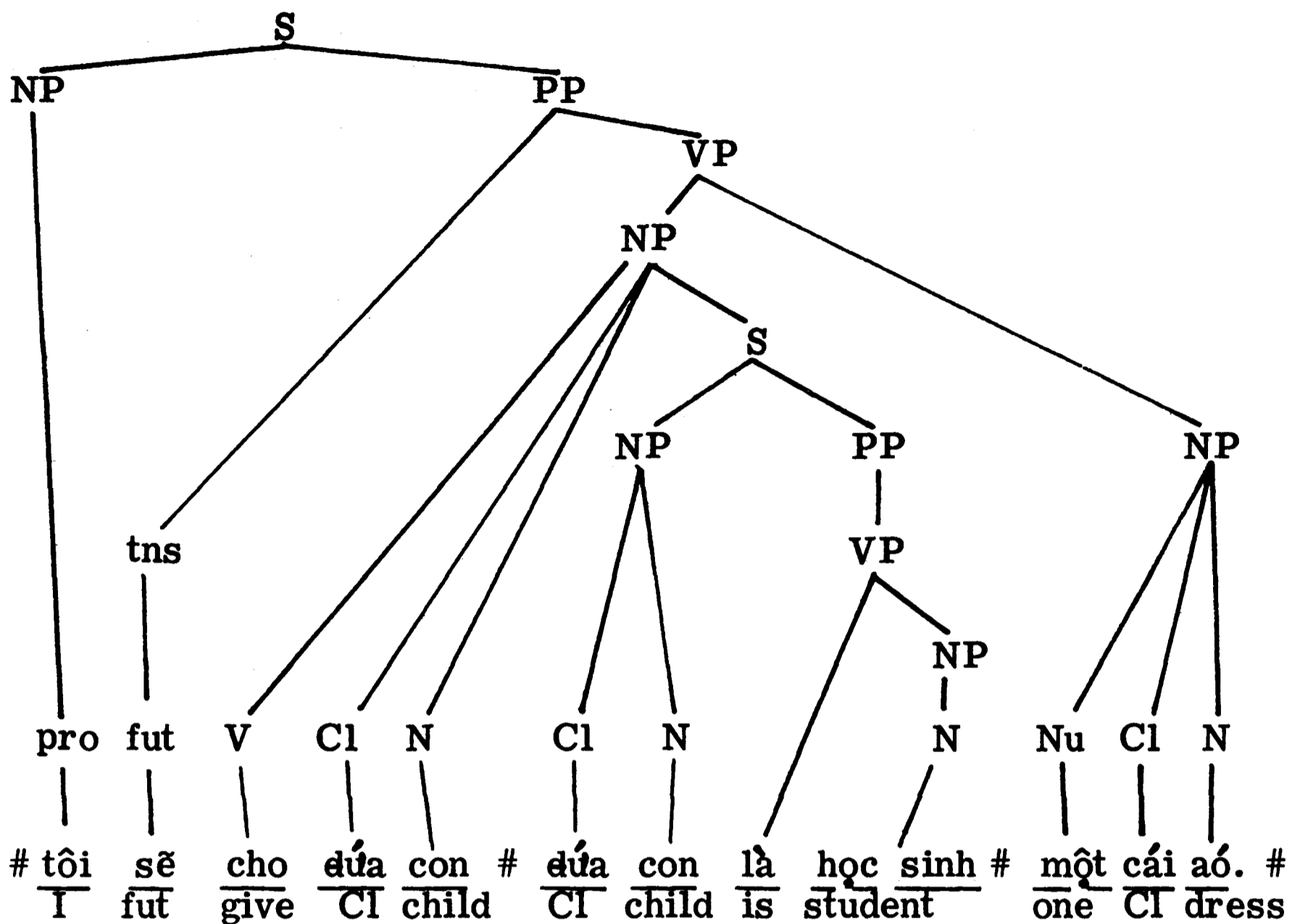

'I will give the child who is a student a dress.'

Only two transformations are obligatory to convert trees G and H to the surface structure required by the phonology.<sup>6</sup> The first transformation removes the second occurrence of the shared noun and replaces it with the word mà. Mà is a grammatical marker of many uses as will be seen in the following section, and it is not readily translatable into English. Perhaps for these reasons Emeneau (1951:206) called it "probably the hardest word in the language to describe accurately." The condition necessary for the application of transformation (1) is that a noun of the matrix sentence and a noun of the embedded sentence with accompanying numeral and demonstratives, if such are present, must be identical. It is not necessary that the two classifiers be identical since there is to a small degree a selection of classifiers used with the same noun.<sup>7</sup>

In this transformation and those following, the symbols Q, U, W, X, Y, Z are variables. That is, they represent segments which are not directly pertinent to the transformation or they may be null. The segments in the transformations are numbered in such a way as to make it more readily apparent to the reader what elements have been deleted or added or changed in order. The symbol  $\emptyset$  is to be



- 7)  $\frac{\text{Đứa}}{\text{CI}}$   $\frac{\text{con}}{\text{child}}$   $\frac{\text{đưa}}{\text{CI}}$   $\frac{\text{mà}}{\text{---}}$   $\frac{\text{tôi}}{\text{I}}$   $\frac{\text{sẽ}}{\text{fut}}$   $\frac{\text{cho}}{\text{give}}$   $\frac{\text{một}}{\text{one}}$   $\frac{\text{cái}}{\text{CI}}$   $\frac{\text{áo}}{\text{dress}}$   $\frac{\text{là}}{\text{is}}$

$\frac{\text{học}}{\text{student}}$   
 $\frac{\text{sinh.}}{\text{---}}$

'The child to whom I'm going to give a dress is a student'

- 8)  $\frac{\text{Tôi}}{\text{I}}$   $\frac{\text{sẽ}}{\text{fut}}$   $\frac{\text{cho}}{\text{give}}$   $\frac{\text{đứa}}{\text{CI}}$   $\frac{\text{con}}{\text{child}}$   $\frac{\text{đưa}}{\text{CI}}$   $\frac{\text{mà}}{\text{---}}$   $\frac{\text{là}}{\text{is}}$   $\frac{\text{học}}{\text{student}}$   $\frac{\text{sinh}}{\text{---}}$   $\frac{\text{một}}{\text{one}}$   $\frac{\text{cái}}{\text{CI}}$   $\frac{\text{áo}}{\text{dress}}$

'I'm going to give the child who is a student a dress.'

In addition to the obligatory transformations already given, there are other transformations which are optional. These transformations are freely chosen to apply or not to apply to sentences which fulfill the conditions of their descriptions.

Transformation (3) optionally inserts the word thì before the predicate phrase of a matrix sentence or any non-embedded sentence or following condition, cause, or time, where these are sentence initial. It need not apply, but its non-application results in the occurrence of certain ambiguities as will be seen later.

Transformation (3) Optional: Insertion of thì.

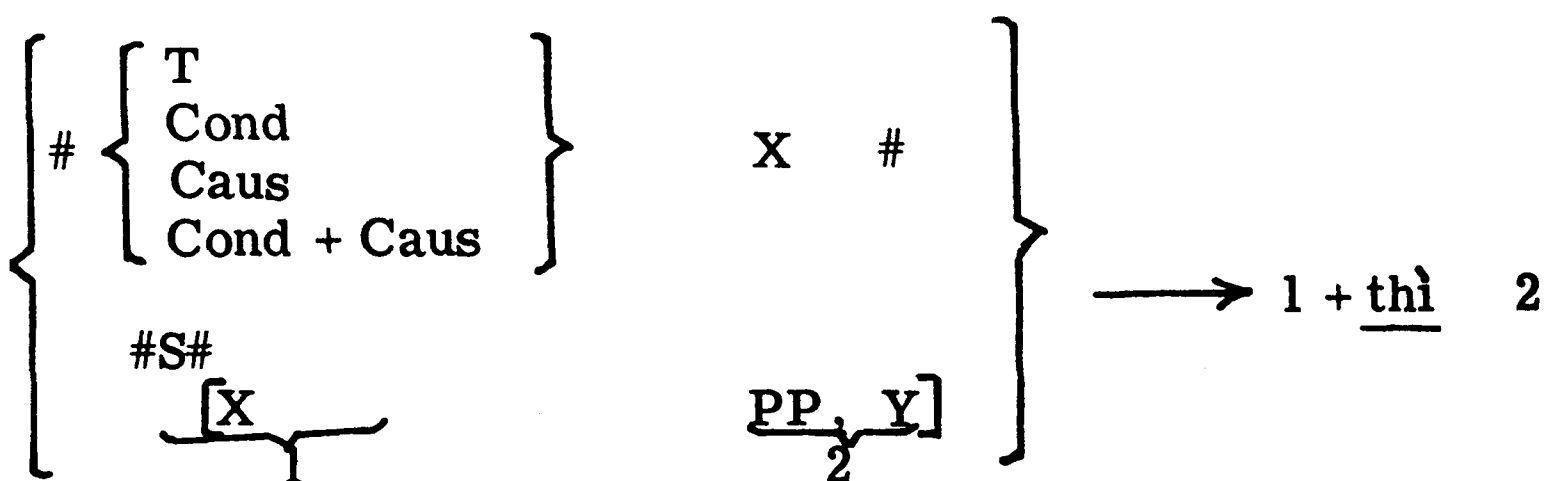

Condition: #S# is not a constituent of another node.

This transformation, if chosen to apply to the preceding trees, would produce sentences such as the following:

- 9)  $\frac{\text{Đứa}}{\text{CI}}$   $\frac{\text{con}}{\text{child}}$   $\frac{\text{thì}}{\text{---}}$   $\frac{\text{khóc.}}{\text{cry}}$  'The child is crying.'
- 10)  $\frac{\text{Đứa}}{\text{CI}}$   $\frac{\text{con}}{\text{child}}$   $\frac{\text{thì}}{\text{---}}$   $\frac{\text{là}}{\text{is}}$   $\frac{\text{học}}{\text{student}}$   $\frac{\text{sinh.}}{\text{---}}$  'The child is a student.'
- 11)  $\frac{\text{Đứa}}{\text{CI}}$   $\frac{\text{con}}{\text{child}}$   $\frac{\text{đưa}}{\text{CI}}$   $\frac{\text{mà}}{\text{---}}$   $\frac{\text{trễ}}{\text{late}}$   $\frac{\text{thì}}{\text{---}}$   $\frac{\text{khóc.}}{\text{cry}}$  'The child who is late is crying.'
- 12)  $\frac{\text{Đứa}}{\text{CI}}$   $\frac{\text{con}}{\text{child}}$   $\frac{\text{đưa}}{\text{CI}}$   $\frac{\text{mà}}{\text{---}}$   $\frac{\text{tôi}}{\text{I}}$   $\frac{\text{sẽ}}{\text{fut}}$   $\frac{\text{cho}}{\text{give}}$   $\frac{\text{một}}{\text{one}}$   $\frac{\text{cái}}{\text{CI}}$   $\frac{\text{áo}}{\text{dress}}$   $\frac{\text{thì}}{\text{---}}$   $\frac{\text{là}}{\text{is}}$

$\frac{\text{học}}{\text{student}}$   $\frac{\text{sinh.}}{\text{---}}$  'The child to whom I will give a dress is a student.'

Transformation (4) optionally deletes Cl or mà or both from an embedded sentence where they occur.

Transformation (4) Optional: Deletion of Cl and/or mà.

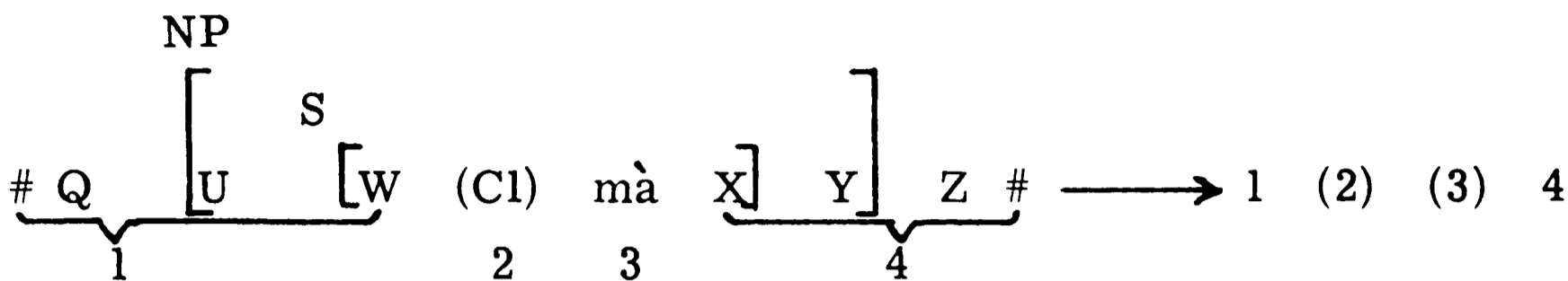

The application of this transformation produces sentences such as:

13) Đứa con (đứa) (mà) khóc (thì) trễ.  
 Cl child Cl cry late

'The child who is crying is late.'

14) Tôi (thì) sẽ cho đứa con (đứa) (mà) là học sinh  
 I fut give Cl child Cl is student  
một cái áo.  
 one Cl dress

'I will give the child who is a student a dress.'

15) Đứa con (đứa) (mà) trễ (thì) khóc.  
 Cl child Cl late cry

'The child who is late is crying.'

Transformation (5) optionally moves the relative clause to the end of the sentence.

Transformation (5) Optional: Extraposition of relative clause.

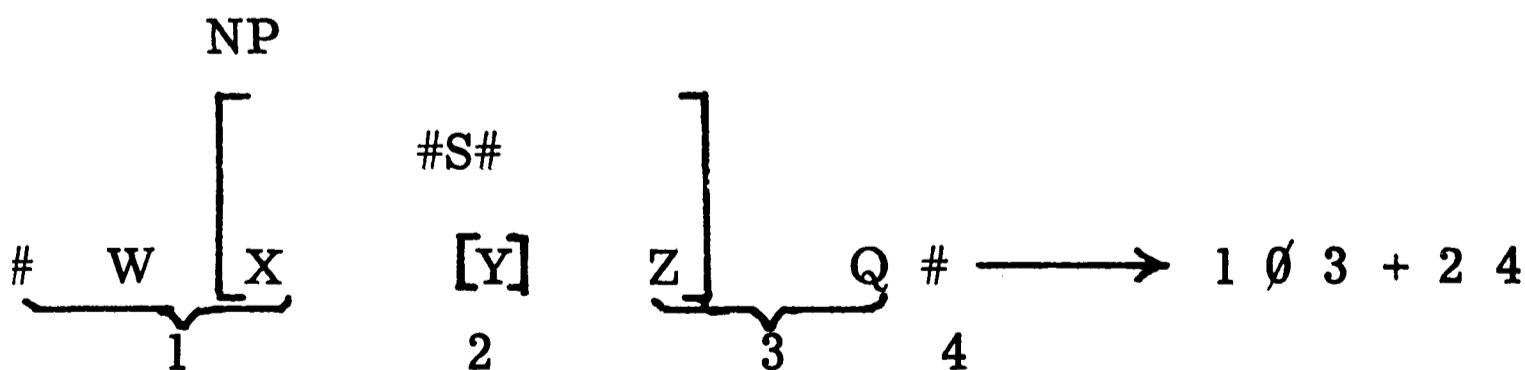

This transformation, if applied, would take sentences 13), 14), and 15) above and make them read:

16) Đứa con (thì) trễ (đứa) (mà) khóc.  
 Cl child late cry

'The child is late who is crying.'

17) Tôi (thì) sẽ cho đứa con một cái áo (đứa)  
 I fut give Cl child one Cl dress Cl

(mà) là học sinh.  
 who is a student

'I will give the child a dress who is a student.'

18) Đứa con (thì) khóc (đứa) (mà) trễ.  
 CI child cry CI late

'The child is crying who is late.'

Two types of ambiguity may result from the application of the preceding transformations. The first type is ambiguity of embedding. If one were to select Underlying Tree C and apply to it transformations 1) and 4), the resulting sentence would be:  $\frac{\text{Đứa con}}{\text{CI child}} \frac{\text{khóc trễ}}{\text{cry late}}$  meaning 'The child who is crying is late.' If, on the other hand, one should select Underlying Tree D and apply to it transformations 1), 4), and 5), the resulting sentence would also be  $\frac{\text{Đứa con}}{\text{CI child}} \frac{\text{khóc trễ}}{\text{cry late}}$  but meaning this time 'The child is crying who is late.' So that, given the form  $\frac{\text{Đứa con}}{\text{CI child}} \frac{\text{khóc trễ}}{\text{cry late}}$  in isolation, it is impossible to say which of sentences 1) and 2) was the matrix sentence and which the embedded. And although the total information in both cases is the same, the emphasis is quite different.

The second type of ambiguity, which more strongly affects the meaning of a sentence, was mentioned in the introduction. It is ambiguity of antecedent. This is illustrated below.

### Underlying Tree I

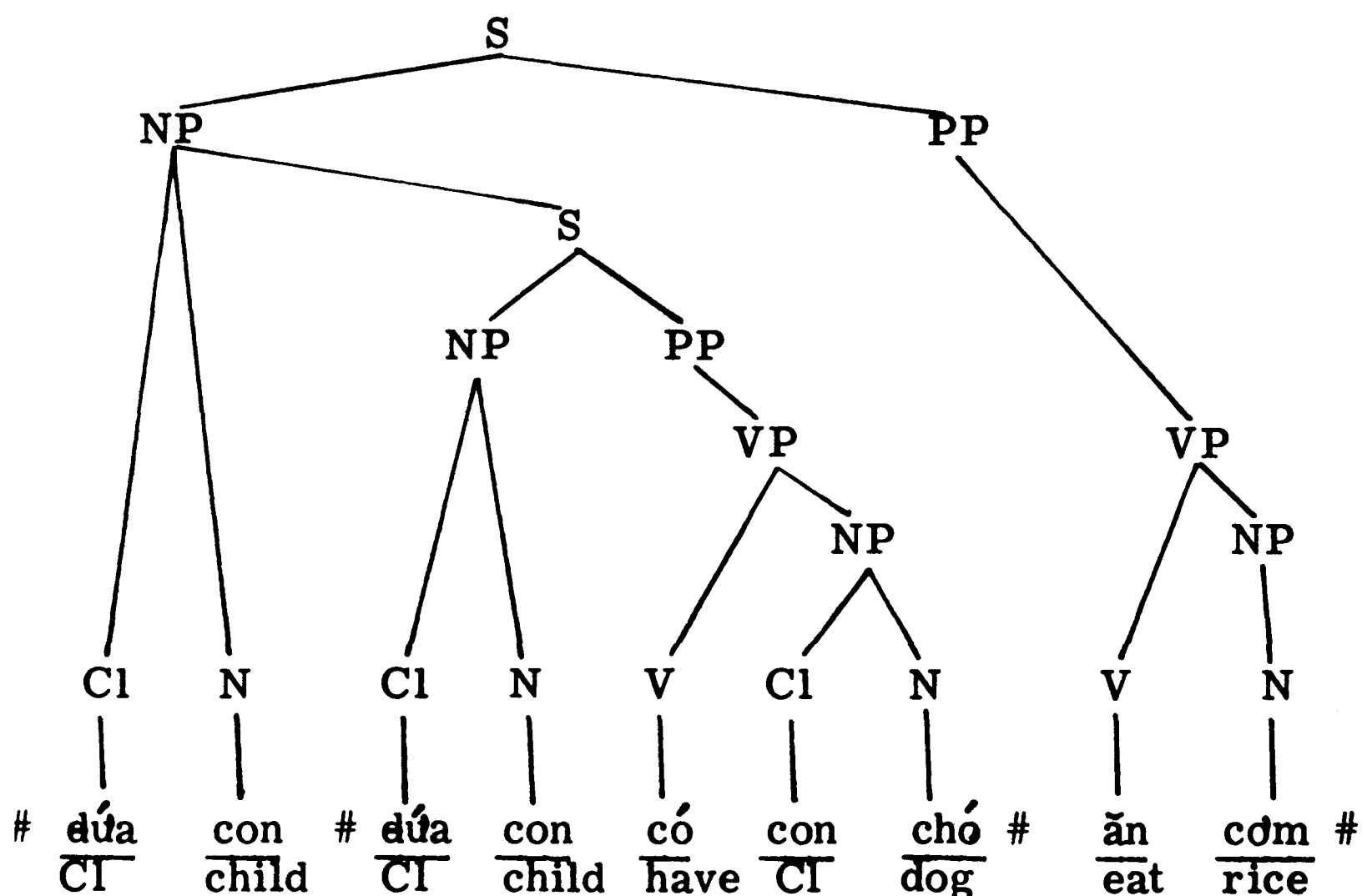

'The child who has a dog is eating rice.'

## Underlying Tree J

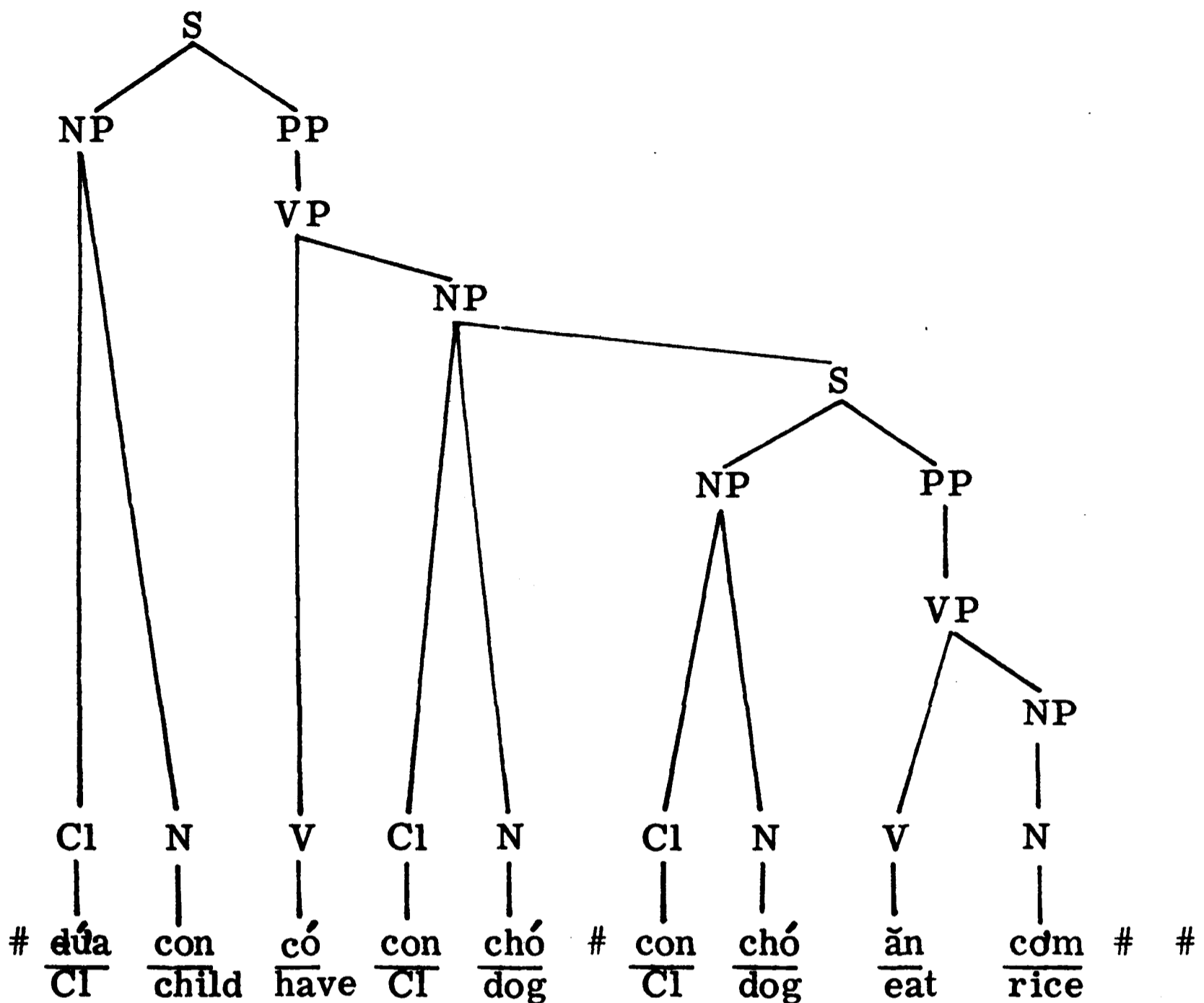

'The child has a dog which is eating rice.'

If one applies transformations 1) and 4) to trees I and J above, deleting both CI and mà, the sentence Đứa con có con chó  
CI child have CI dog  
ăn cơm results in both cases. So the sentence could be under-

stood to mean either 'The child who has a dog is eating rice.' or 'The child has a dog which is eating rice.' It could be disambiguated by placing thì before the word ăn as coming from Tree I or by placing thì before có as coming from Tree J (Transformation 3)). It can also be disambiguated by replacing CI and mà deleted by Transformation 4).

4. Ambiguity With Other Constructions. In addition to the ambiguity which may exist between two possible structural interpretations of the relative clause as shown previously, the relative clause may also be ambiguous with certain other constructions. These include the verbal complement, purpose, condition, cause, condition plus cause, time, and factive. This section will show the underlying representation of each of these constructions and give the transformations which may apply to them to produce at some point a reading which is ambiguous with the relative clause.

4.1 Verbal Complement.

## Underlying Tree K

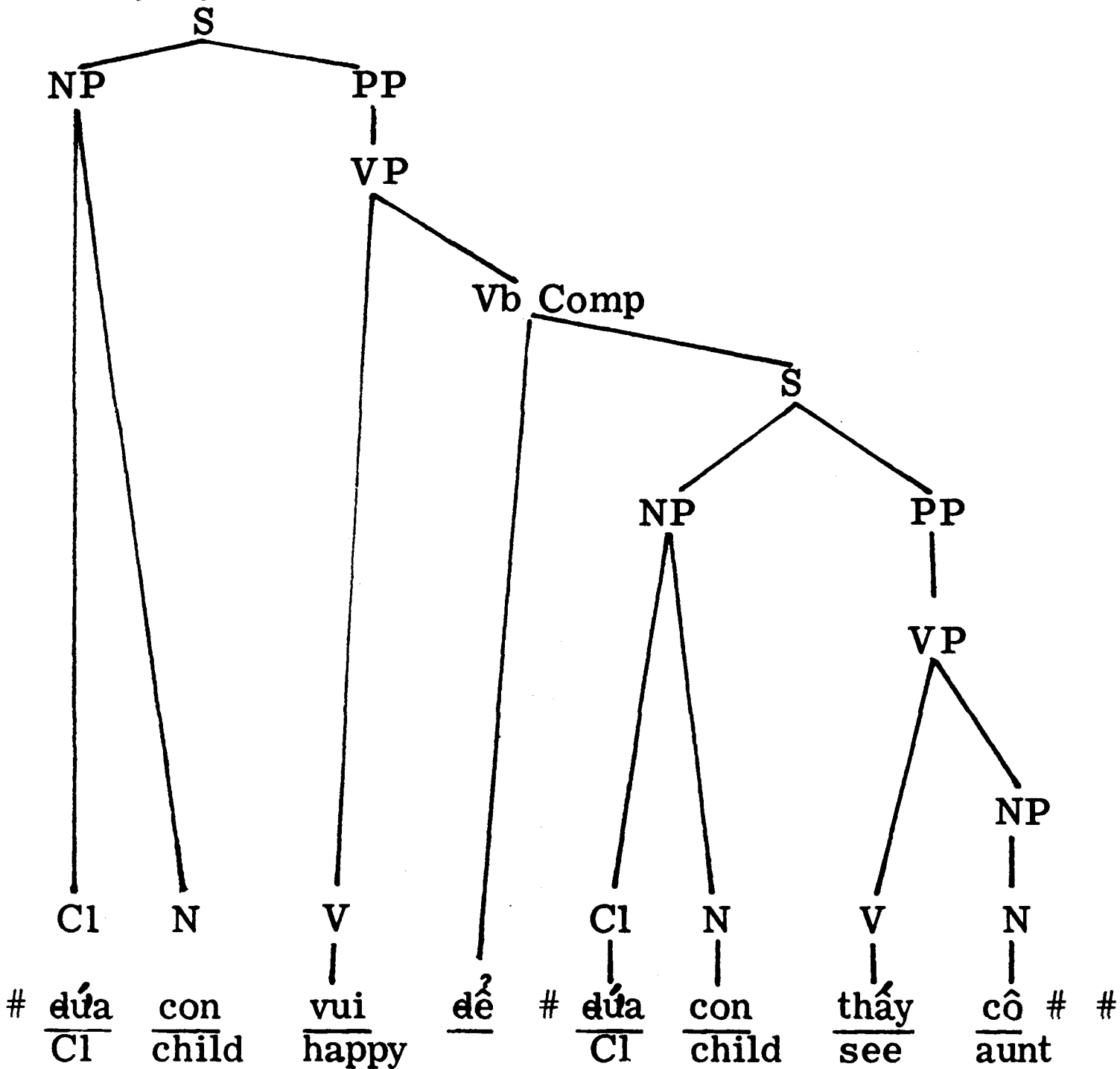

'The child is happy to see his aunt.'

To the underlying tree above, obligatory transformation (1) presented with the Relative Clause will apply to replace the shared noun in the embedded sentence with mà. This produces the combination (Cl) mà. For the verbal complement construction, however, it is also necessary to delete Cl, should this be present. Obligatory transformation (6) does this.

Transformation (6) Obligatory: Deletion of Cl.

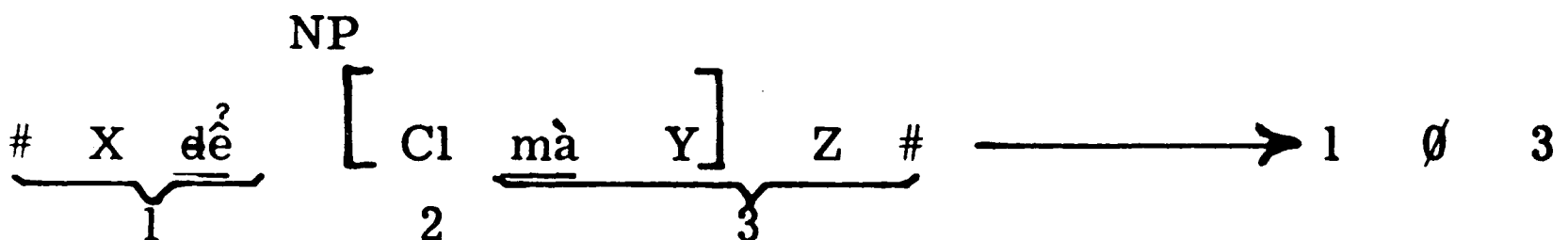

The application of transformation (1) and transformation (6) to Tree K above will produce the following sentence:



- 19) Đứa con vui đế mà thấy cô.  
 CI child happy see aunt  
 'The child is happy to see his aunt.'

Transformations (9) and (10) are optional and may be applied to delete mà whenever it occurs with nếu or đế and to delete đế when it precedes an embedded sentence. These transformations are numbered to apply after the transformations presented in sections 4.2 and 4.3.

Transformation (9) Optional: Deletion of mà with nếu or đế.

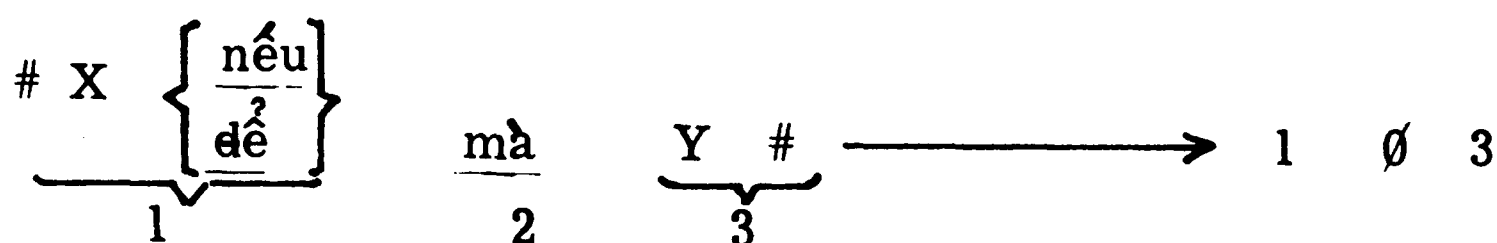

Transformation (10) Optional: Deletion of nếu, đế, bởi vì, khi.

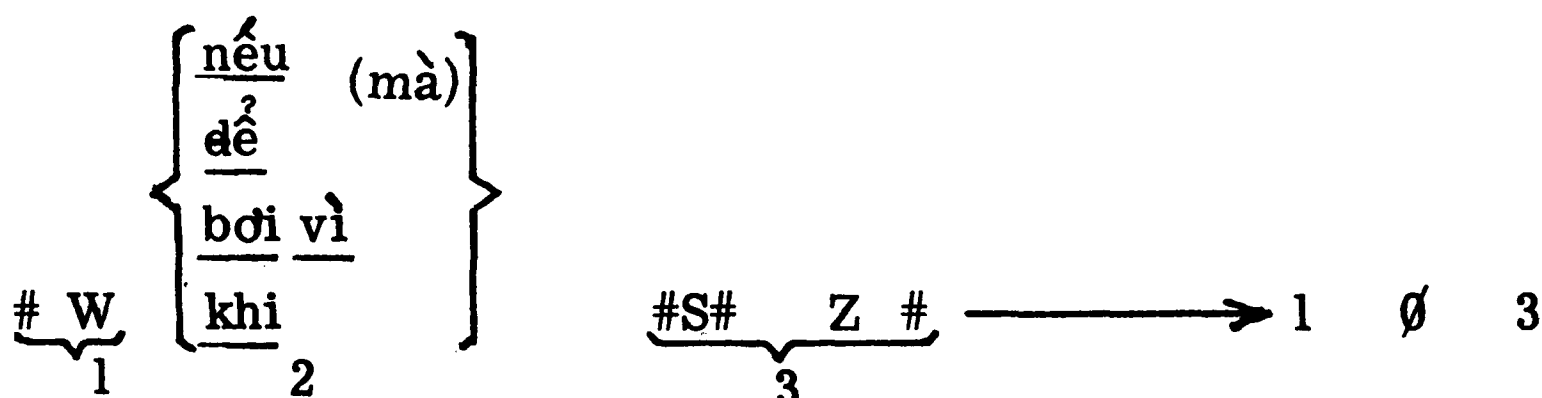

Condition: When 2 is dominated by T, Cond, or Caus, Z may not be null.

After the application of transformations (9) and (10), sentence 19) above may have either đế or mà deleted or both as shown below:

- 20) Đứa con vui (đế) (mà) thấy cô.  
 CI child happy see aunt  
 'The child is happy to see his aunt.'

In its minimal form, that is with all optional elements deleted, Underlying Tree K with a verbal complement construction becomes ambiguous with the relative clause construction. The sentence Đứa con vui thấy cô, CI child happy see aunt (sentence 20), could also be understood as having been derived from the embedding of the sentence Đứa con vui. CI child happy ('The child is happy.') into the sentence Đứa con thấy cô. CI child see aunt ('The child sees his aunt.') and the application of transformations (1) and (4). If the sentence were derived in this way, it would mean 'The child who is happy sees his aunt.' It could also be understood as having been derived from the embed-

ding of the sentence Đứa con thấy cô.

Cl child see aunt ('The child sees his aunt.')

into the sentence Đứa con vui.

Cl child happy ('The child is happy.')

and the application of transformations (1), (4), and (5). In this case it would mean 'The child who sees his aunt is happy.'

4.2 Purpose. The purpose construction has an underlying structure very similar to that of the verbal complement except that for it Purp is chosen from the rule expanding the verb phrase (see base rule 3) instead of Vb Comp.

Underlying Tree L:

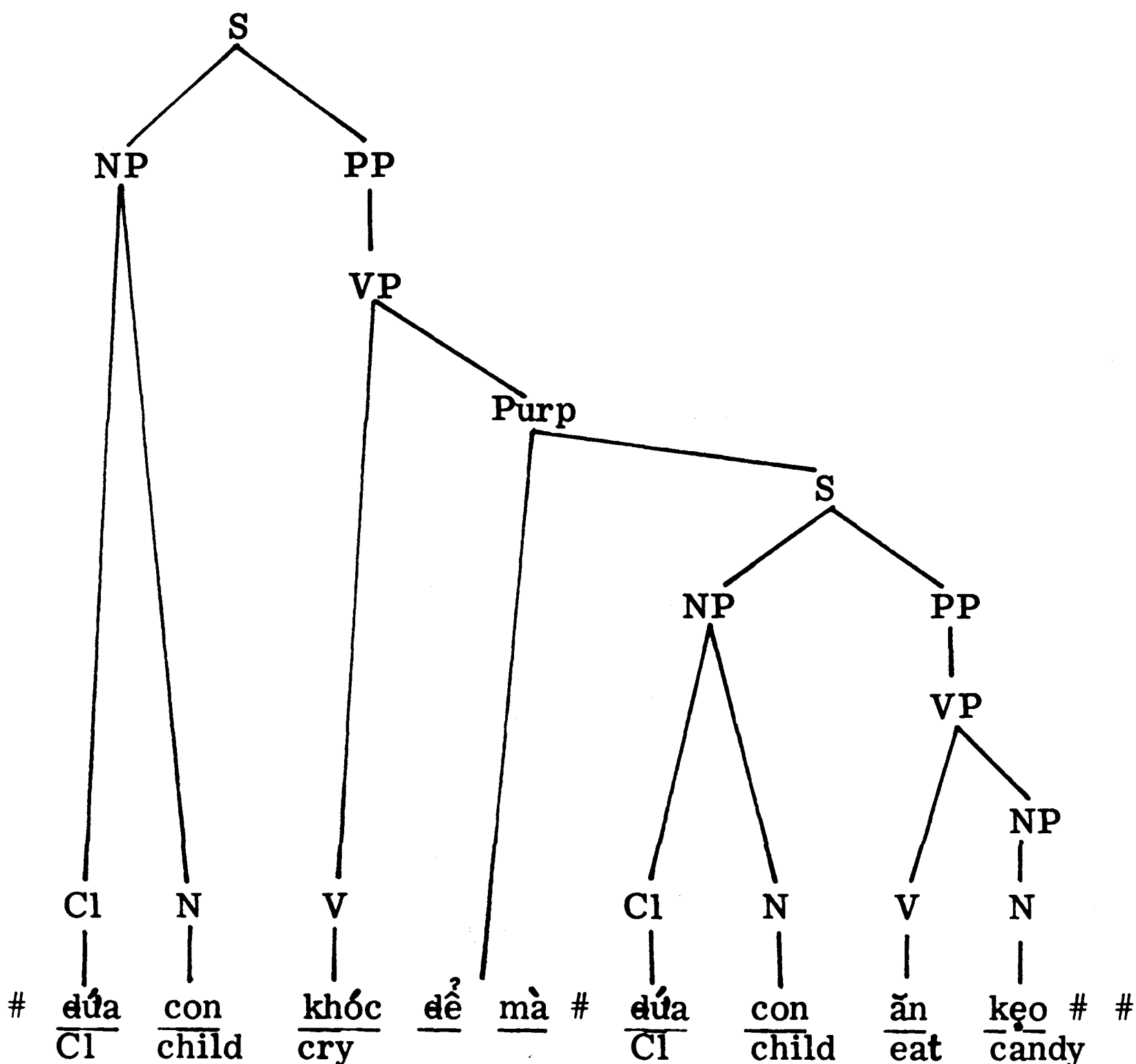

'The child is crying to eat candy.'

No transformations are obligatory to this construction. Of the transformations already presented, transformation (3) may apply to the above tree to insert thì before the predicate phrase. So the sentence Đứa con (thì) khóc để mà đứa con ăn kẹo is a

grammatically acceptable sentence.

Transformation (7), however, will optionally delete the second occurrence of a particular noun phrase within a sentence or replace it with a pronoun.

Transformation (7) Optional: Deletion of shared NP or replacement with pro

#S#

$$[X \text{ NP } Y \text{ NP } Z] \longrightarrow 1 \quad 2 \quad 3 \quad \left\{ \begin{array}{c} \emptyset \\ \text{pro} \end{array} \right\} \quad 5$$

Condition: 2 + 4

Should the noun phrase subject of the embedded sentence not be shared by that of the matrix sentence, transformation (7) will not delete it but allow it to remain, as in the sentence:

Đứa con khóc để mà mẹ cho keo. 'The child is crying  
 Cl child cry mother give candy  
 so that his mother will give him candy.'

Optional transformations (9) and (10) may apply to delete để or mà or both, so the possible sentences generated with purpose will include:

21) Đứa con (thì) khóc (để)(mà)(đứa con) ăn keo.  
 Cl child cry Cl child eat candy

'The child is crying to eat candy.'

22) Đứa con (thì) khóc (để)(mà)(mình) ăn keo.  
 Cl child cry self eat candy

'The child is crying to eat candy!'

23) Đứa con (thì) khóc (để)(mà) mẹ cho keo.  
 Cl child cry mother give candy

'The child is crying so that his mother will give him candy.'

Of these sentences, several possible combinations are structurally ambiguous with the relative clause. The form,

Đứa con (thì) khóc (mà) ăn keo. of sentence 21) and 22) could  
 Cl child cry eat candy

also be derived from the embedding of the sentence

Đứa con ăn keo 'The child is eating candy' into the sentence  
 Cl child eat candy

Đứa con khóc 'The child is crying.' The form,  
 Cl child cry

Đứa con khóc ăn kẹo of sentences 21) and 22) might also be derived from the same embedding or from the reverse embedding. So that it might mean 'The child is crying to eat candy,' 'The child who is eating candy is crying,' or 'The child is eating candy who is crying.'

Sentence 23) could be produced in minimal form by embedding Me cho đứa con kẹo 'The mother gave the child candy' into Đứa con khóc 'The child is crying' with the resultant CI child cry meaning 'The crying child is the one to whom the mother gave candy.'

Structural ambiguity between the verbal complement construction and the purpose construction is limited to the occurrence of the small subcategory of verbs which may occur with both purpose and verbal complement as noted in section 2. Within this small subcategory of verbs which may occur with both constructions structural ambiguity seems almost always to exist. Trees M and N illustrate this.

Tree M might pass through all the transformations relevant to it and come out in surface structure Đứa con trễ (để)(mà) đi bộ meaning 'The child was late so as to walk.' That is, he came late on purpose so that he could walk. If the optional (mà) were deleted, the above sentence would be identical with the sentence produced by Tree N after it had passed through all the transformations pertinent to it. Only in this case the meaning would be 'The child was late in walking.' That is, he learned to walk later than most children. In its minimal form, the above sentence could also be derived from a relative clause construction so that it could mean either, 'The child who is late is walking,' or 'The child who is walking is late.'

Underlying Tree M: Purpose

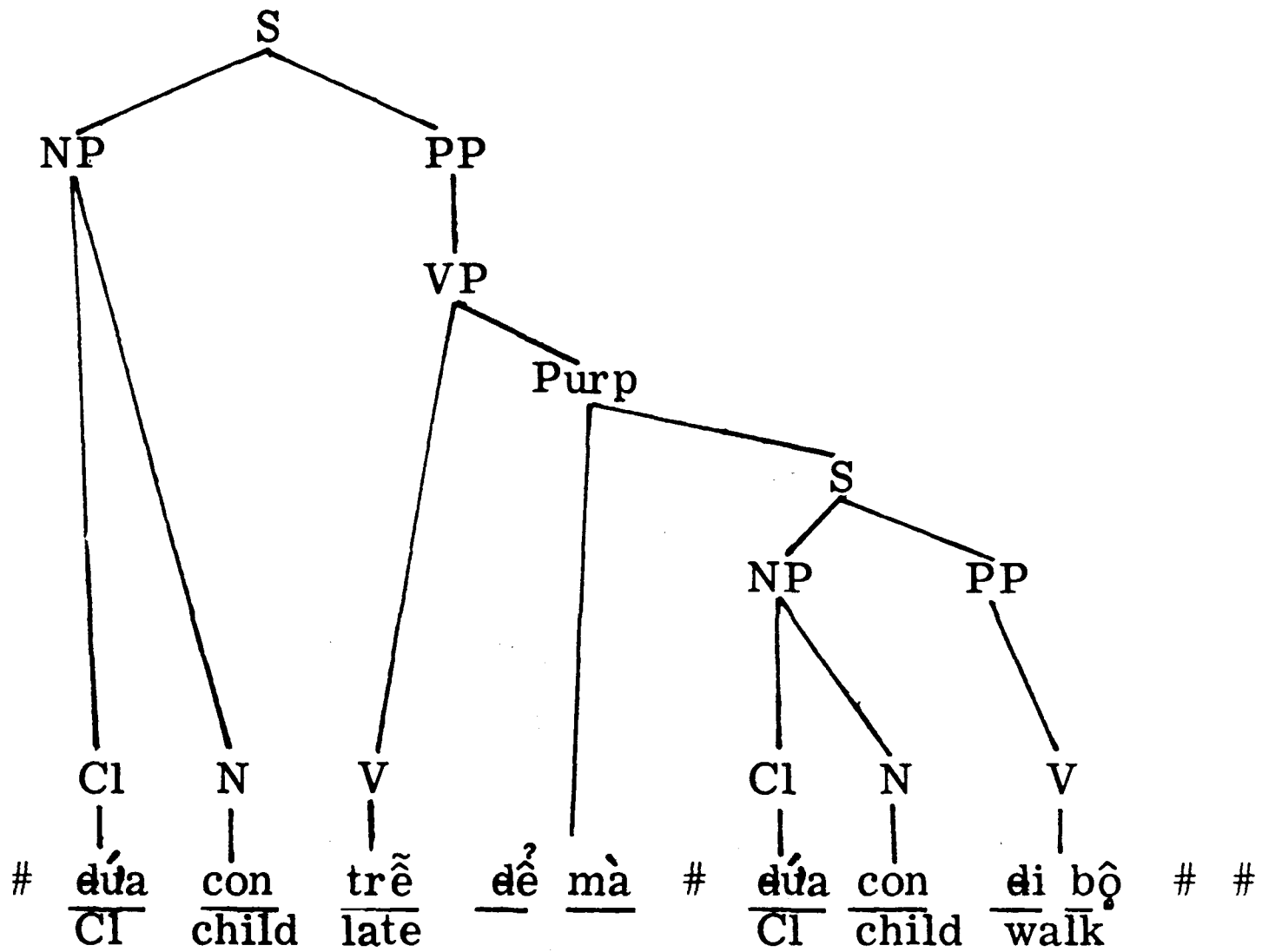

'The child was late so as to walk.'

Underlying Tree N: Verbal complement

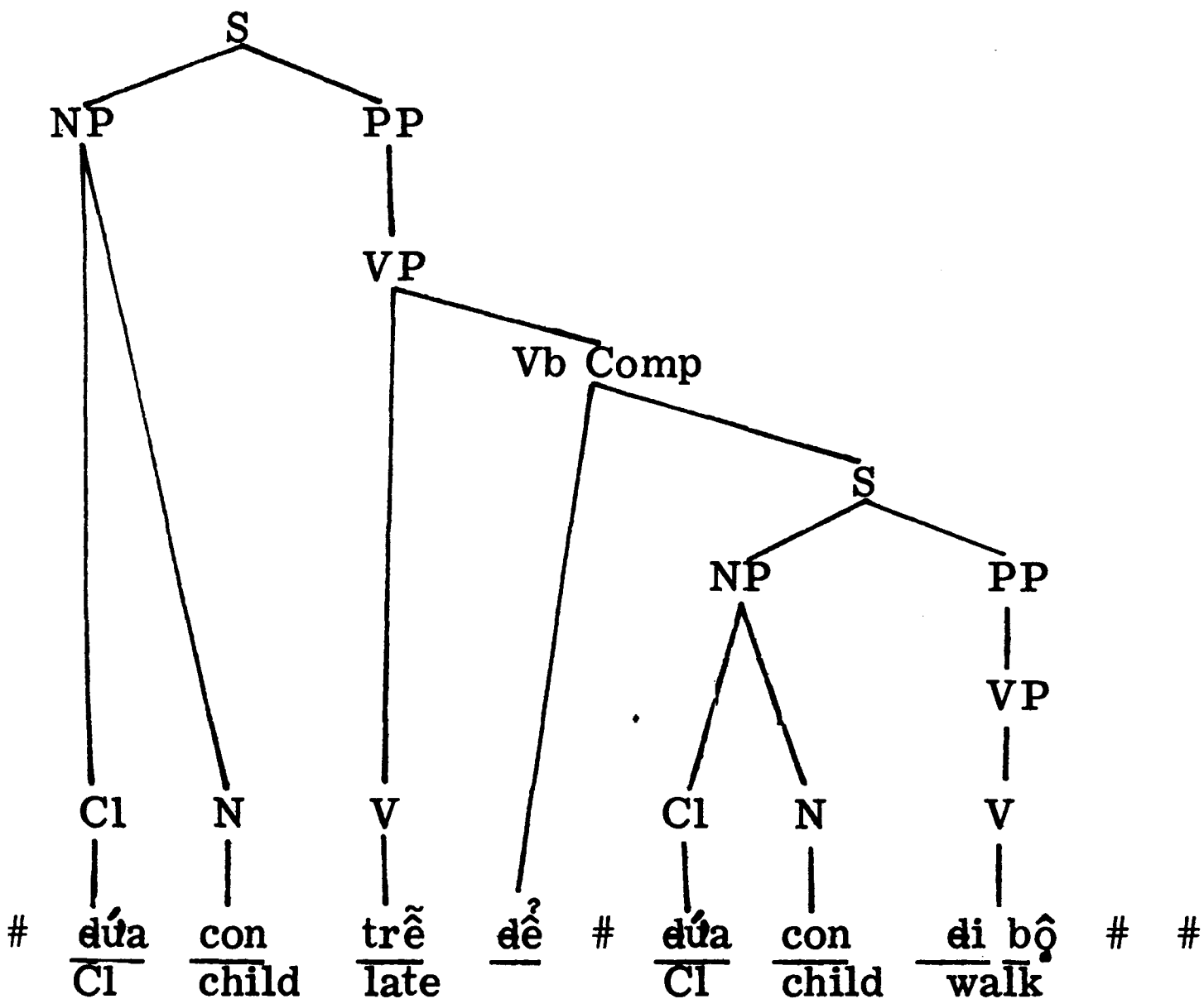

'The child was late in walking.'

4.3 Condition.

## Underlying Tree O

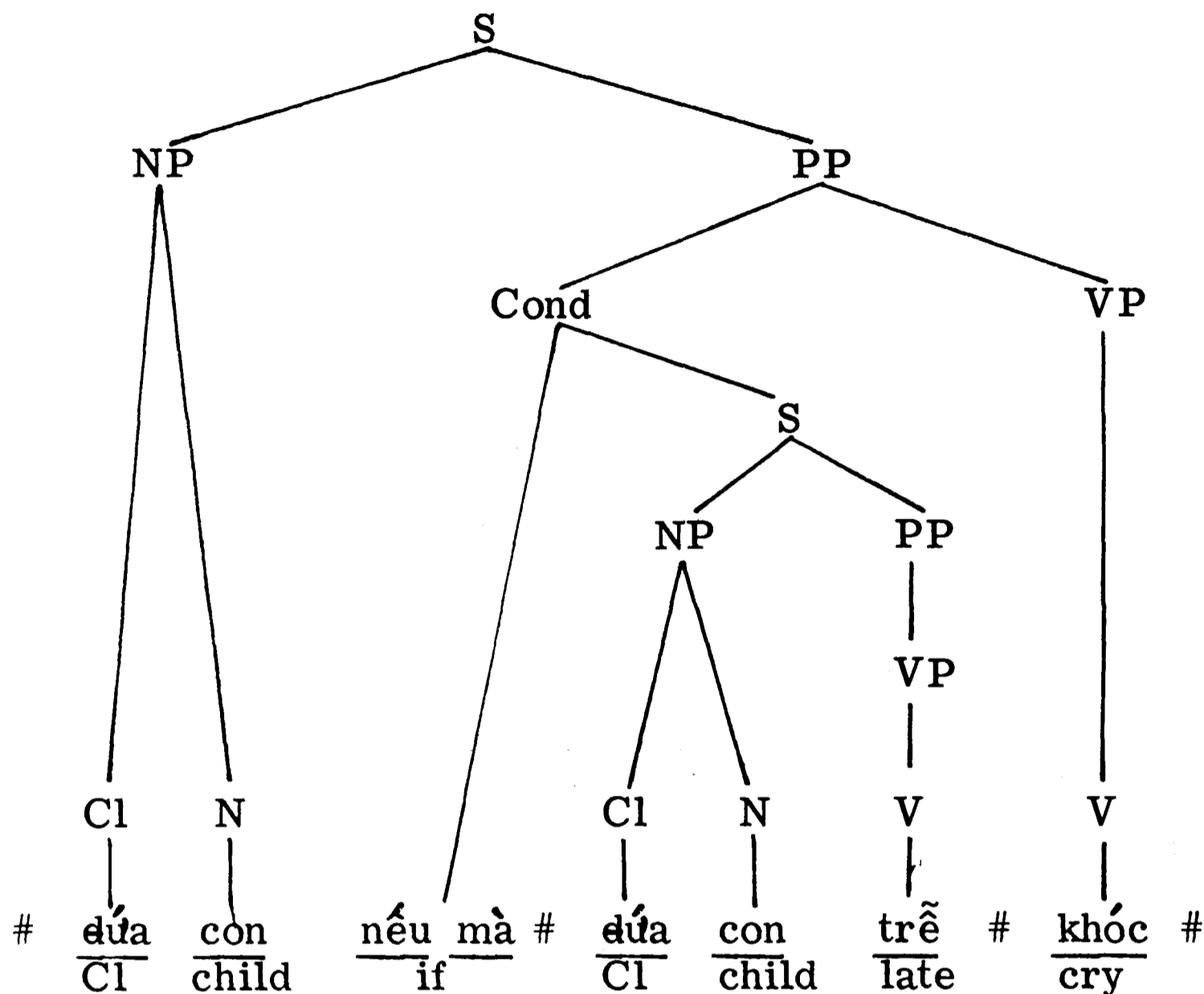

'If the child is late he will cry.'

No transformations are obligatory in converting Tree O to surface structure. So, the sentence Đứa con nếu mà đứa con trễ khóc 'If the child is late he will cry.' is grammatically acceptable

in Vietnamese. There are, however, several optional transformations which may apply to produce sentences which are more commonly used. Transformation (3) may apply to insert thì before the predicate phrase of the matrix sentence. Transformation (7) will optionally delete the second occurrence of đứa con or replace it

with a pronoun. A shared noun will not always be present, however as in the sentence Đứa con nếu mà mẹ đánh em (thì) khóc 'If his mother spanks his younger-brother the child will cry.'

Transformation (8) will optionally move the part of the sentence dominated by condition, cause, or both to either the beginning or the end of the sentence.

Transformation (8) Optional: Extraposition of Cond, Caus, or Cond + Caus

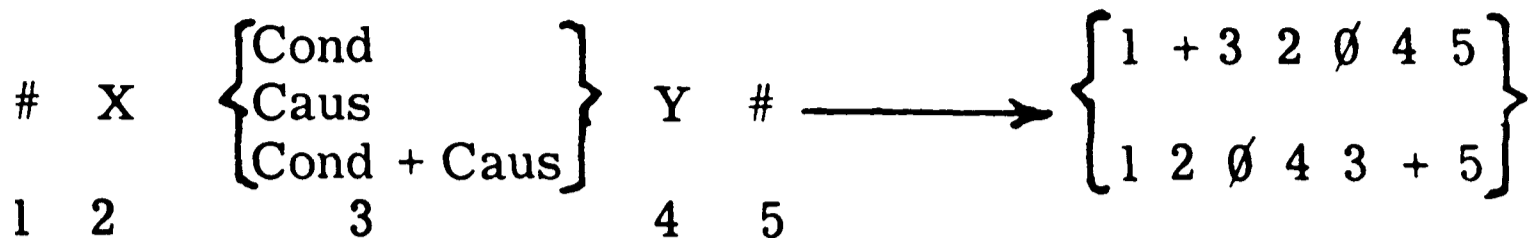

If transformation (8) has operated to move Cond, Caus, or Cond + Caus to the front of the sentence, transformation (3) may optionally insert *thì* following it. If transformation (8) has operated to move Cond, Caus, or Cond + Caus to the end of the sentence, transformation (10), which deletes grammatical markers such as *nếu*, will not allow these to be deleted in this position. *Mà* however, may be deleted by transformation (9) in whatever position the construction occurs.

The following sentences are illustrative of those containing condition:

24) Đứa con (nếu)(mà) trễ (thì) (nó) khóc.  
 Cl child if late he cry

'If the child is late he will cry.'

25) (Nếu)(mà) đứa con trễ (thì)(đứa con) khóc.  
 if Cl child late Cl child cry

'If the child is late he will cry.'

26) Đứa con khóc nếu (mà)(nó) trễ.  
 Cl child cry if he late

'If the child is late he will cry.'

27) (Nếu)(mà) mẹ đánh em (thì) đứa con khóc.  
 if mother spank younger-brother Cl child cry

'If his mother spanks his younger brother, the child will cry.'

28) Đứa con khóc nếu (mà) mẹ đánh em.  
 Cl child cry if mother spank younger-brother

'If his mother spanks his younger brother, the child will cry.'

Sentence 24) above illustrates a number of possible ambiguities. If, from that sentence, *nếu* and *nó* are omitted leaving *thì* and either taking or leaving *mà*, the sentence could be understood as being derived from Tree D by the application of transformations (1), (3), and (4). Its meaning would be 'The child who is late is crying.' If all deletable items are omitted from sentence 24), it could be understood as being derived from Tree D by the application of transformations (1) and (4) with the same meaning as was just noted. Or it could be understood as being derived from Tree C by the application of transformations (1), (4) and (5) with the meaning 'The child is late

who is crying'; from Tree M (if đi bộ is replaced by khóc) by the application of transformations (7), (9), and (10) with the meaning 'The child is late (on purpose) so as to cry'; or from Tree N (also with đi bộ replaced by khóc) by the application of transformations (1), (6), (9), and (10) with the meaning 'The child is late in crying.'

#### 4.4 Cause.

##### Underlying Tree P

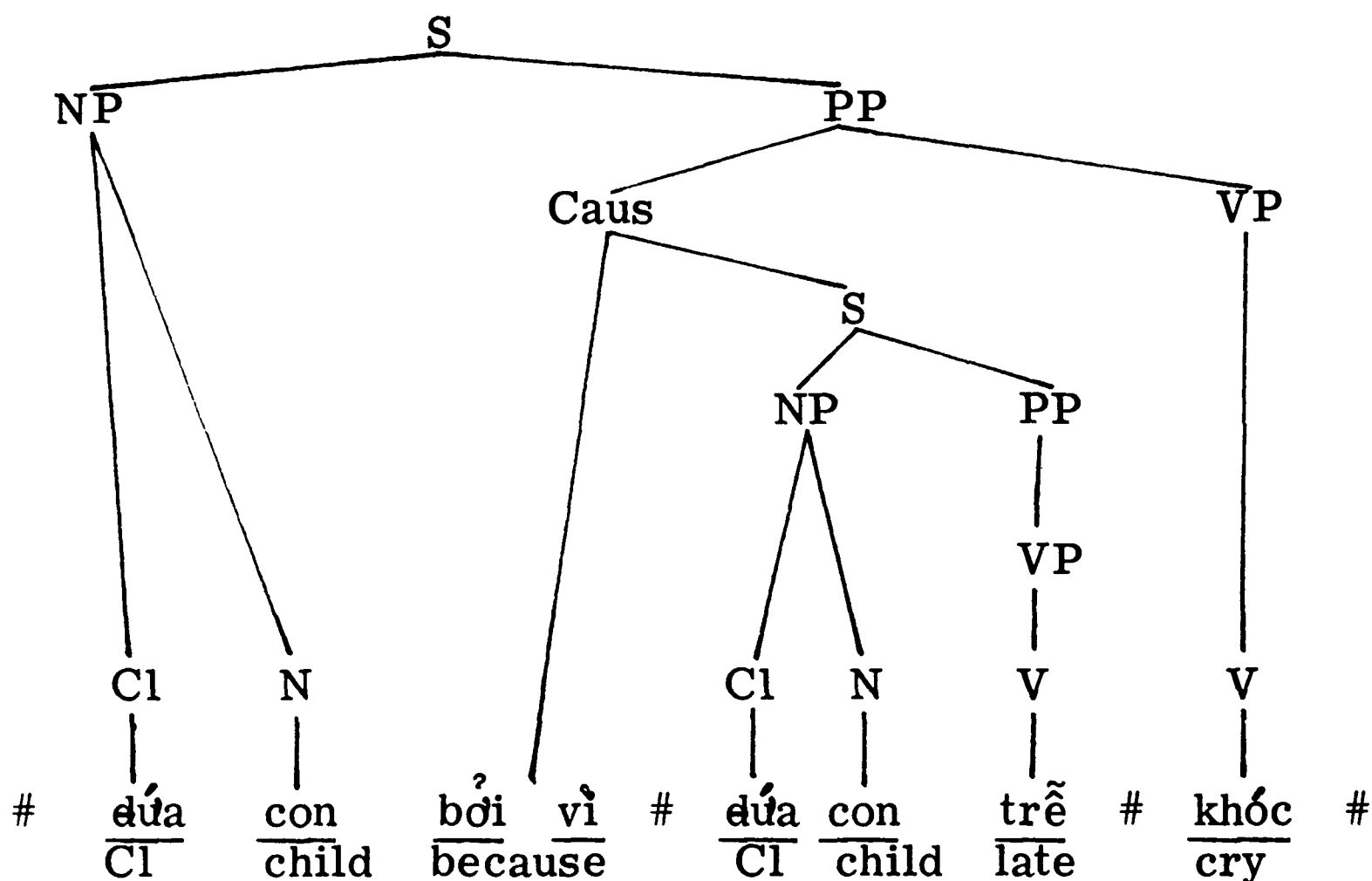

'The child is crying because he's late.'

A sentence containing cause is very similar in underlying structure to the conditional sentence. It is also similar to the conditional sentence in the transformations which it may undergo. Like the conditional sentence, the causal sentence requires no transformations to convert it to surface structure. The sentence Đứa con bởi vì đứa con trễ khóc 'The child is crying because he's late' is grammatically acceptable.

To underlying tree P, however, several optional transformations may apply. Transformation (7) may delete the shared noun phrase or replace it with a pronoun. Transformation (7) will not apply, however, where no shared noun is present as, for example in the sentence Đứa con bởi vì con chó chết khóc 'The child is crying because the dog died.' Transformation (10) will optionally delete bởi vì if transformation (8) has not moved Caus to the end of



the sentence. If transformation (8) has moved Caus to the beginning of the sentence, transformation (3) may optionally insert thì to follow Caus. It may, in any case, insert thì before the predicate of the matrix sentence.

The following sentences, then, may be generated from the underlying tree containing cause:

29) (B<sup>?</sup>ởi vì) đứa con trễ (thì) (đứa con) khóc.  
 Because CI child late CI child cry

'The child is crying because he is late.'

30) (B<sup>?</sup>ởi vì) đứa con trễ (đứa con) (thì) khóc.  
 Because CI child late CI child cry

'The child is crying because he is late.'

31) Đứa con (b<sup>?</sup>ởi vì) (đứa con) trễ (thì) khóc.  
 CI child because CI child late cry

'The child is crying because he is late.'

32) Đứa con (thì) khóc b<sup>?</sup>ởi vì (đứa con) trễ.  
 CI child cry because CI child late

'The child is crying because he is late.'

33) (B<sup>?</sup>ởi vì) con chó chết (thì) đứa con khóc.  
 Because CI dog die CI child cry

'The child is crying because the dog died.'

34) Đứa con (thì) khóc b<sup>?</sup>ởi vì con chó chết.  
 CI child cry because CI dog die

'The child is crying because the dog died.'

It can easily be seen that when the causal particle, bởi vì, is deleted, the causal sentence is identical with the conditional sentence when its particle, nếu mà, is deleted and is thus ambiguous with it. In its minimal form in sentences 29), 30), and 31), with all optional items deleted, the causal may be ambiguous with relative clause, condition, purpose, and verbal complement. This was demonstrated for this particular sentence in Sec. 4.3. The vocabulary in the illustrative sentences has been restricted for ease in reading and presentation, but the same results could also be shown from other sentences.

4.5 Condition + Cause. As may be noted in the phrase structure rules, it is possible in Vietnamese to have a sentence containing both condition and cause. This might be demonstrated by the following underlying tree. (c)1976 See archives.sealang.net/mks/copyright.htm for terms of use.!

## Underlying Tree Q

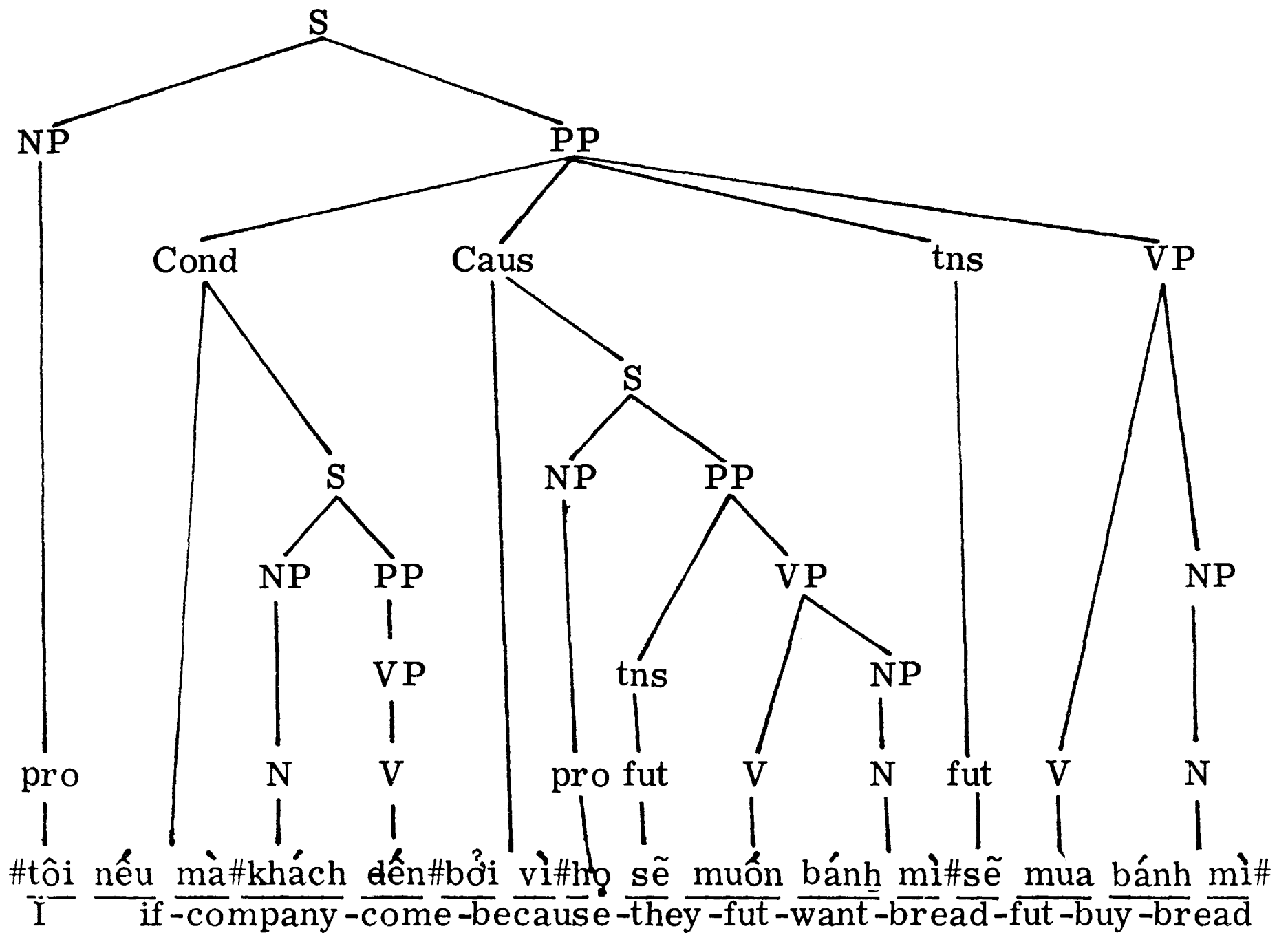

'I will buy bread if company comes because they will want it.'

The transformations given in the preceding discussions of condition and cause will also apply to this construction to optionally delete the second occurrence of bánh mì, to add thì, to move Cond + Caus to the beginning or end of the sentence, and to delete the condition and cause markers. Transformation (11) gives further possibilities for ordering of this double construction.

Transformation (11) Optional: Extraposition of Cond + Caus

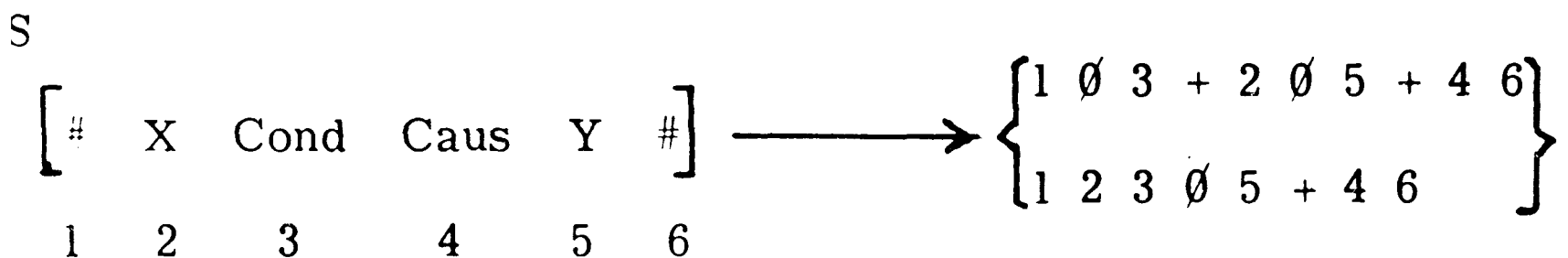

The following sentences will serve to illustrate this construction:

- 35) (Nếu) (mà) khách đến (bởi vì) họ sẽ muốn bánh mì  
 If company come because they fut want bread  
 tôi sẽ mua (bánh mì).  
 I fut buy bread

'If company comes I will buy bread because they will want it.'

36) Tôi (nếu)(mà) khách đến sẽ mua bánh mì bởi vì  
 họ sẽ muốn (bánh mì).  
 I if company come fut buy bread because  
 they fut want bread

'If company comes I will buy bread because they will want it.'

37) (Nếu)(mà) khách đến tôi sẽ mua bánh mì bởi vì  
 họ sẽ muốn (bánh mì).  
 If company come I fut buy bread because  
 they fut want bread

'If company comes I will buy bread because they will want it.'

38) Tôi sẽ mua bánh mì nếu mà khách đến bởi vì  
 họ sẽ muốn (bánh mì).  
 I fut buy bread if company come because  
 they fut want bread

'If company comes I will buy bread because they will want it.'

It is possible for the two sentences embedded in the condition and cause nodes to be identical as in trees R and S. And it is in this case that structural ambiguity with the relative clause is likely to arise.

Underlying Tree R

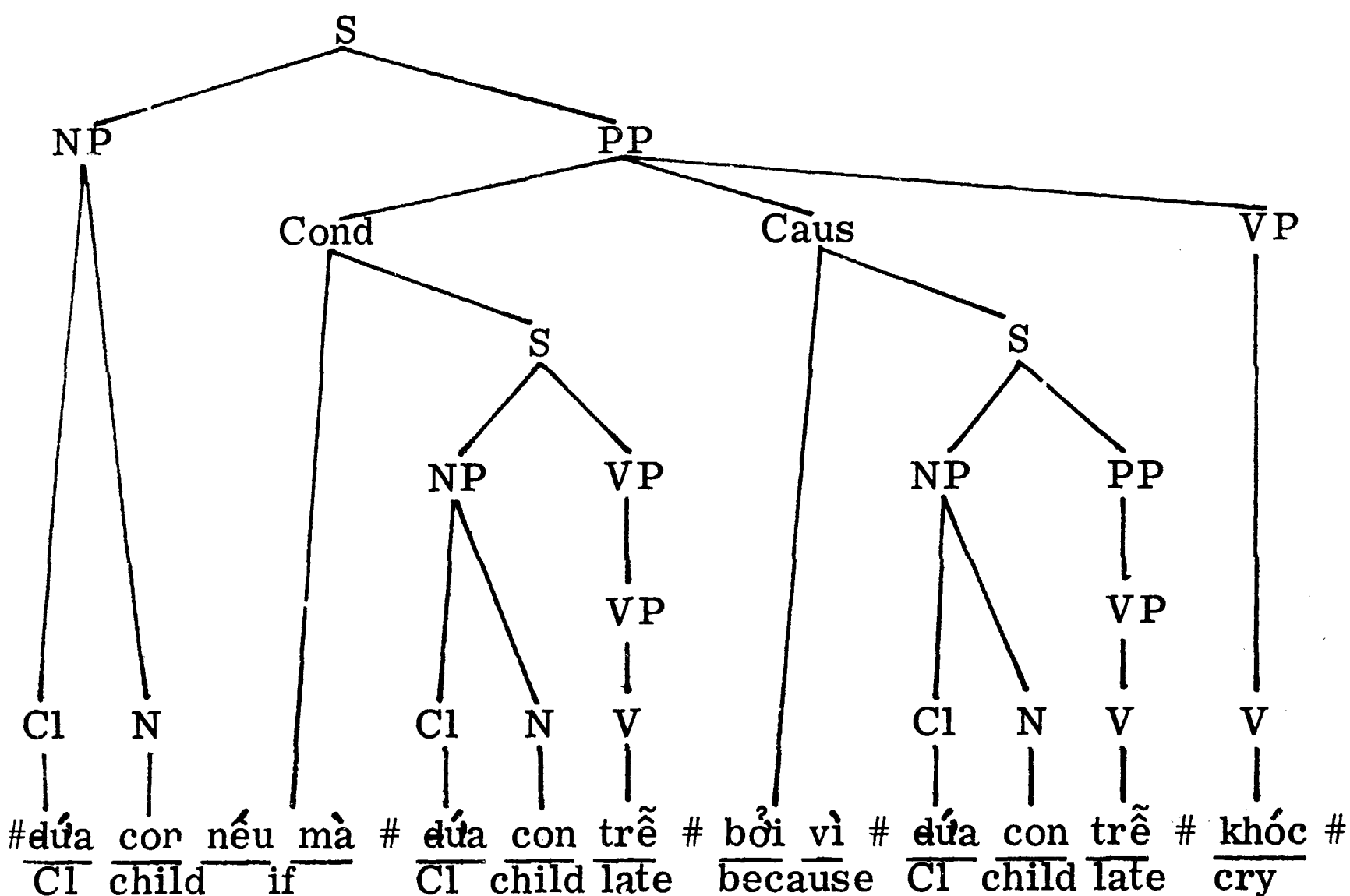

'If the child is late he will cry because he is late.'

## Underlying Tree S

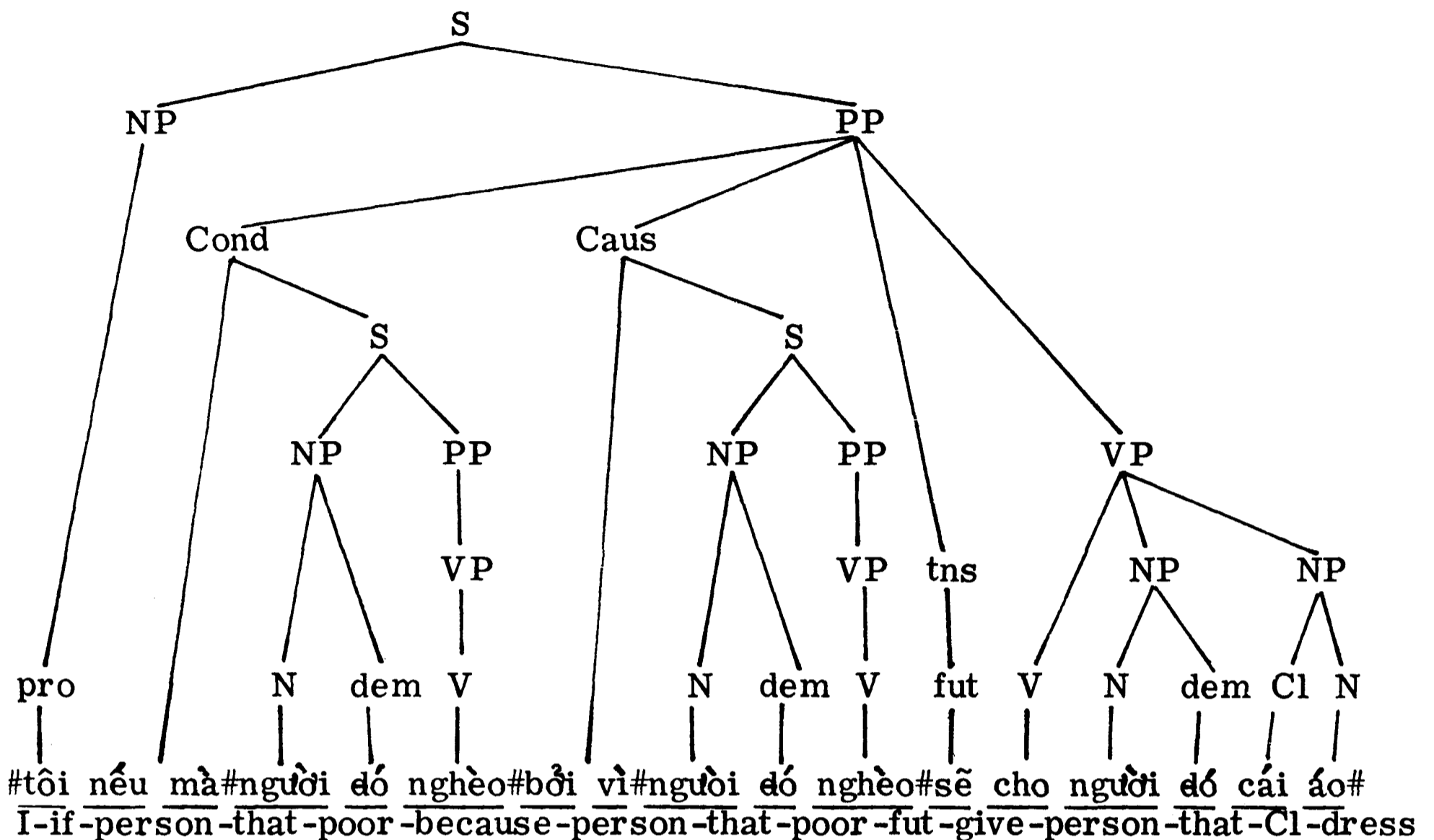

'If that person is poor I will give him a shirt because he is poor.'

The transformations noted for tree Q will also apply to trees R and S. If, however, the condition and cause constructions are not separated from each other by transformations (8) or (11), transformation (12) will obligatorily delete the second occurrence of the shared sentence.

Transformation (12) Obligatory: Deletion of shared S

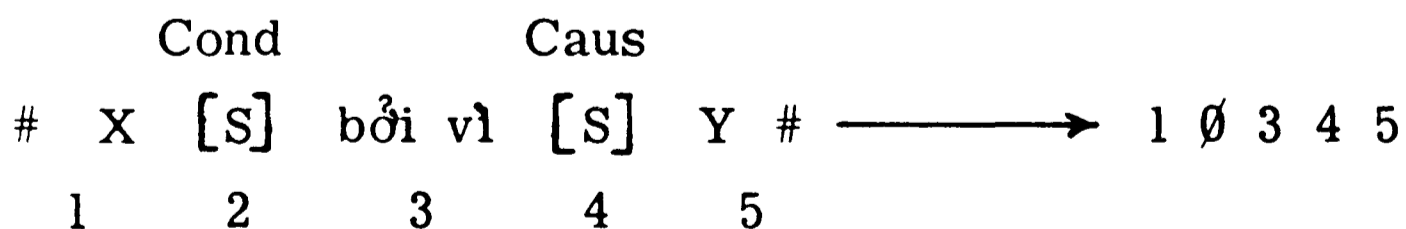

Condition: 2 = 4

The application of this transformation would result in the following sentences:

39) Đứa con (nếu)(mà)(bởi vì) (đứa con) trễ (thì) khóc.  
Cl child if because Cl child late cry

'If the child is late he will cry because he is late.'

40) (Nếu)(mà)(bởi vì) đứa con trễ (thì)(đứa con) khóc.  
 If because CI child late CI child cry

'If the child is late he will cry because he is late.'

41) Đứa con (thì) khóc nếu mà bởi vì (đứa con) trễ.  
 CI child cry if because CI child late

'If the child is late he will cry because he is late.'

42) (Nếu)(mà)(bởi vì) người đó nghèo (thì) tôi sẽ cho  
 If because person dem poor I fut give  
 (người đó) cái áo.  
 person that CI shirt

'If that person is poor I will give her a dress because she is poor.'

Since, according to my informant, the grammatical markers nếu mà and bởi vì in this construction may be deleted (see transformations (9) and (10)), the range of ambiguities for this construction with tree R would be the same as that given for trees O and P (Sec. 4.3). That is, it could become ambiguous in its minimal form with relative clause, purpose, verbal complement, simple condition, or simple cause. Tree S could be ambiguous with all of these except verbal complement since the verb nghèo does not occur with verbal complement.

#### 4.6 Factive.

##### Underlying Tree T

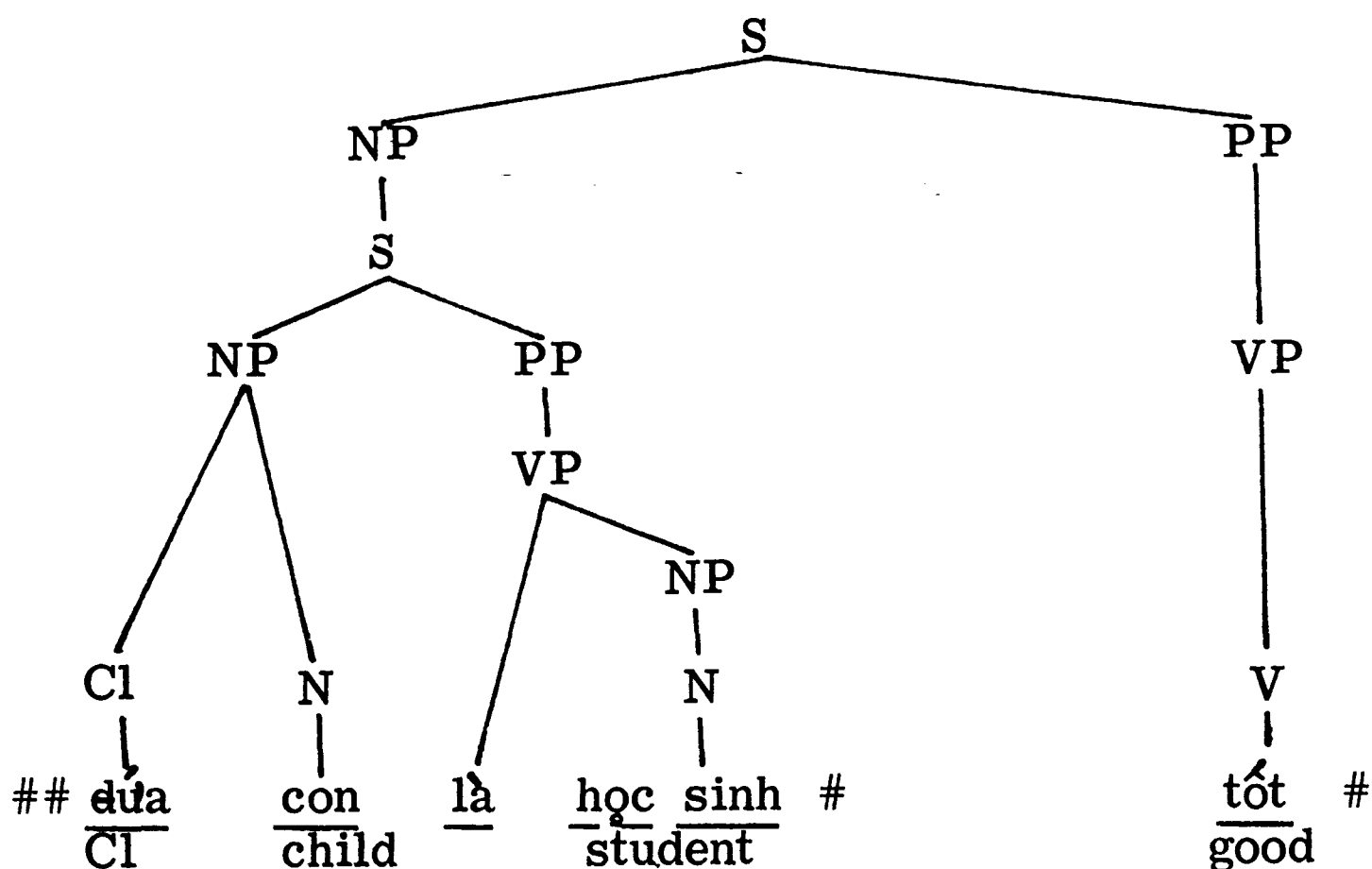

'The fact that the child is a student is good.'

The factive construction is limited in that it may occur with only a small number of verbs such as tốt 'good,' xấu 'bad,' khó 'dif-

difficult, or dễ 'easy' plus a verbal complement, etc. No restrictions, however, have been noted concerning the sentence occurring as the representation of NP except that imperatives or question are disallowed.

No transformations are required to convert underlying tree T to surface structure. The sentence, Đứa con là học sinh tốt, is grammatically acceptable. Transformation (3) may be applied to place thì before the verb tốt.

In some instances the sentence manifesting the noun phrase subject of the matrix sentence might undergo obligatory transformations. The equational sentence occurring here as the noun phrase undergoes no obligatory transformations, but it may have là deleted by optional transformation (13).

Transformation (13) Optional: Deletion of là

#	X	<u>là</u>	Y	#	→	1	2	∅	4	5
1	2	3	4	5						

Condition: 2 and 4 may not contain #.

In surface structure, tree T should produce the sentence:

43) Đứa con (là) học sinh (thì) tốt.  
       CI child student good

°The fact that the child is a student is good.°

This sentence, in its complete form is ambiguous with a sentence containing relative clause in which the CI and mà have been deleted (°The child who is a student is good°). It is also ambiguous with a sentence containing condition (°If the child is a student he is good°); cause (°Because the child is a student he is good°); condition plus cause (°If the child is a student he is good because he is a student°); or purpose (°The child is a student so that he will be good°).

Should thì be omitted from sentence 43), three possible relative clause constructions could be understood: 1) °The child who is a student is good.° 2) °The child is a good student.° (literally °a student which is good°) 3) °The child who is good is a student.°

4.7 Time. A sentence containing a time construction may also be ambiguous with several of the constructions already presented.

Underlying Tree U

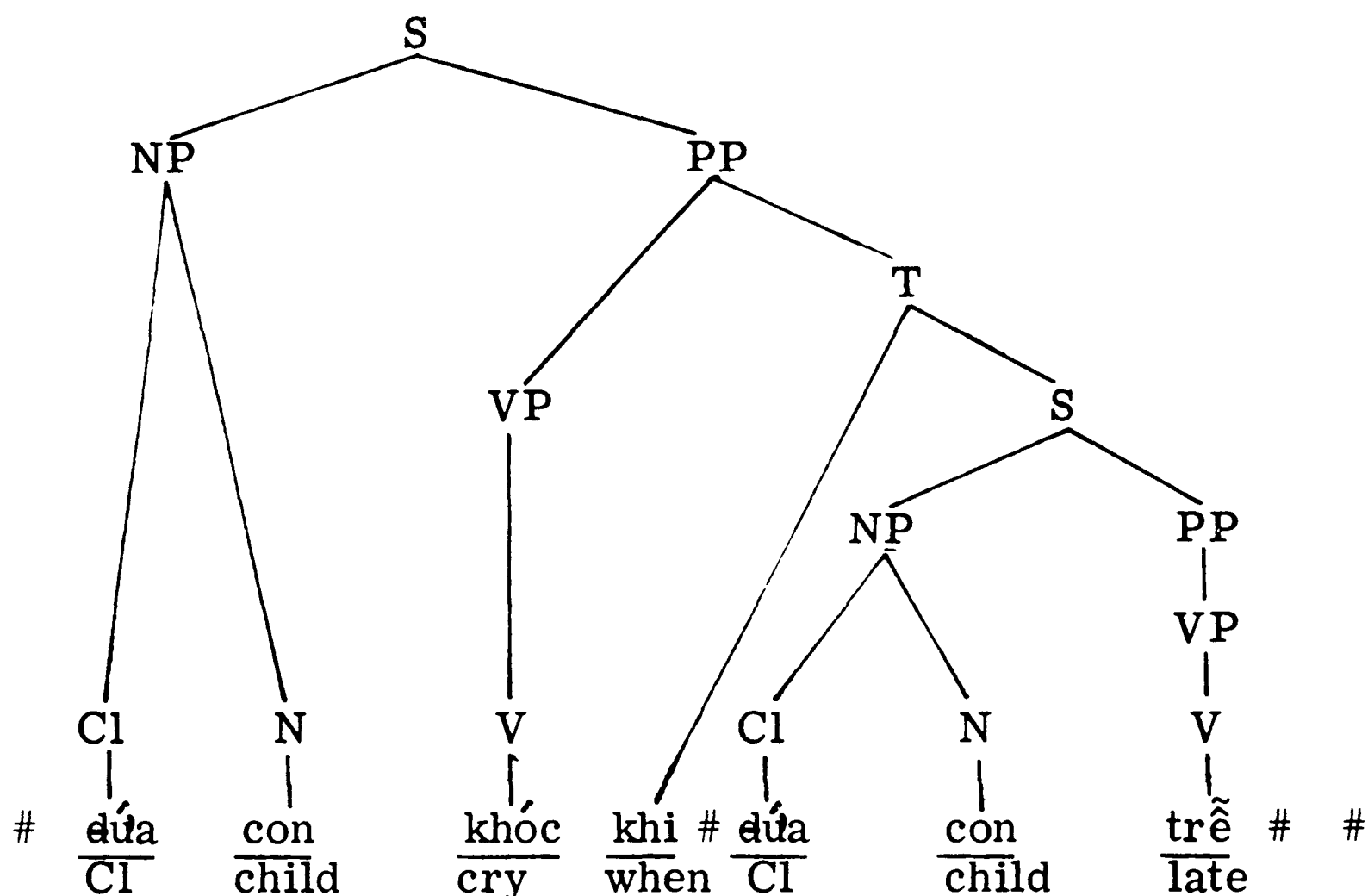

'The child cries when he is late.'

No obligatory transformations apply to tree U, so the sentence Đứa con khóc khi đứa con trễ 'The child cries when he is late' is permitted in surface structure. Transformation (14) allows the time construction to occur in other positions within the sentence.

Transformation (14) Optional: Extraposition of T

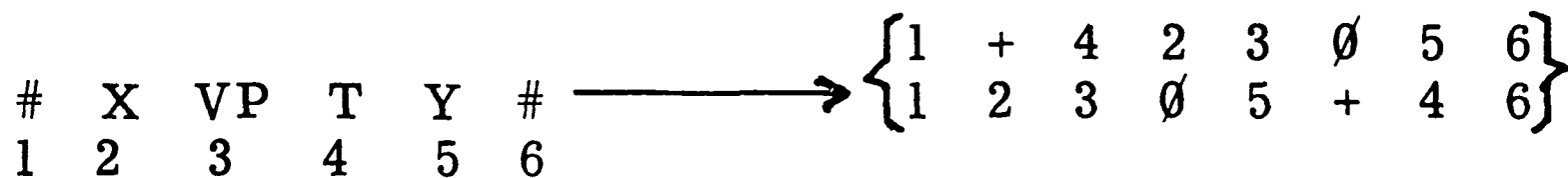

Transformation (7) may optionally delete the second occurrence of đứa con or replace it with a pronoun. Transformation (10) may remove khi if time is in any position other than sentence final. Transformation (3) may insert thì to follow the time construction where it is sentence initial.

The following sentences are among those generated by tree U:

- 44) (Khi) đứa con trễ (thì) (đứa con) khóc.  
 When Cl child late Cl child cry

'When the child is late he cries.'

15) Đứa con khóc khi (đứa con) trễ.  
 Cl child cry when Cl child late

'When the child is late he cries.'

It should be apparent from sentence 44) that when the time marker is deleted, the resulting sentence could be derived from a conditional or causal sentence or the combination of condition and cause. Since a noun in the embedded sentence is shared by a noun in the matrix sentence, the sentence is also ambiguous with the relative clause. And because the verb trễ 'late' may occur with both purpose and verbal complement, as has already been demonstrated, the sentence is also ambiguous with these two constructions.

5. Summary. To show the range of possible ambiguity within the relative clause, all the sentences generated from tree D by the application of relevant transformations are here presented. And it is noted with what other constructions each sentence is ambiguous. Since a given underlying tree has one unambiguous meaning, and since these sentences may all be derived from tree D, they may all have the meaning, 'The child who is late is crying.' But, because they may also be traced back to other underlying tree structures, they may have other possible meanings as follows:

Rel Cl (reverse embedding) 'The child who is crying is late.'  
Vb Comp 'The child is late in crying.'  
Purp 'The child is late so that he can cry.'  
Cond 'If the child is late he will cry.'  
Caus 'Because the child is late he is crying.'  
Cond + Caus 'If the child is late he will cry because he is late.'  
Time 'When the child is late he cries.'

In its most fully expanded form, the derived form of tree D:

<u>Đứa con</u> ( <u>đứa</u> )( <u>mà</u> ) <u>trễ</u> ( <u>thì</u> ) <u>khóc</u>	is unambiguous.
Cl child Cl late cry	
with <u>mà</u> deleted, it	is unambiguous
with <u>mà</u> and <u>thì</u> deleted	is ambiguous with Vb Comp
with <u>thì</u> deleted	is ambiguous with Vb Comp
with <u>đứa</u> deleted	is ambiguous with Cond Cond + Caus Purp
with <u>đứa</u> and <u>thì</u> deleted	is ambiguous with Cond Cond + Caus

Cond + Caus



with đũa and mà deleted

is ambiguous with  
Vb Comp  
Cond  
Caus  
Cond + Caus  
Time

with đũa, mà, and thì deleted

is ambiguous with  
Vb Comp  
Purp  
Cond  
Caus  
Cond + Caus  
Time  
Rel Cl (reverse  
embedding)

with Rel Cl sentence final,  
Đũa con (thì) khóc (đũa)(mà) trê

is unambiguous

with thì deleted

is unambiguous

with thì and đũa deleted

is ambiguous with  
Purp  
Cond  
Cond + Caus

with thì, mà, and đũa deleted

is ambiguous with  
Purp  
Cond  
Caus  
Cond + Caus  
Time  
Rel Cl (reverse  
embedding)

with đũa deleted

is ambiguous with  
Purp

with đũa and mà deleted

is ambiguous with  
Time

with mà deleted

is unambiguous

with thì and mà deleted

is unambiguous

FOOTNOTES:

1. I wish to express appreciation to E. Austin Hale for his help in the organization and writing of this paper, and to acknowledge the help of Richard S. Pittman. Nguyễn Đăng Liêm checked over all the Vietnamese illustrations used in the paper and gave other helpful advice. The paper is based on the author's field observations, and particularly on the speech of Miss Trần Thủy Vân, formerly of Hảiphong, now of Sài Gòn.
2. The verb có 'to have' in its use as 'there are...' is said by Liêm (p. 243) to be subjectless. An alternate treatment would be to consider có in this use as an intransitive verb whose subject must be postposed by an obligatory transformation. For example, in the underlying form Hai người có the absence of an object  

<u>two</u>	<u>people</u>	<u>there are</u>
------------	---------------	------------------

marks có as being intransitive. So an obligatory transformation would change the order of the elements to the surface structure form Có hai người  

<u>there are</u>	<u>two</u>	<u>people</u>
------------------	------------	---------------
3. Although tense is here said to be optional, it might possibly be considered as always present in deep structure and frequently deleted in surface structure as is the NP subject in rule 1.
4. The copula là may be deleted in surface structure everywhere except where it occurs within the VP of a matrix sentence (i. e. a sentence within which another sentence has been embedded).
5. Additional information about verbs and verb constructions may be found in the articles by Thomas and by Gage and Jackson already mentioned.
6. Sentences in surface structure are those to which the phonological rules may apply so that they may be spoken and would be recognized by a native Vietnamese speaker as being grammatical sentences in Vietnamese. All the numbered Vietnamese sentences in this paper are surface structure. That is, all their possible readings have been said to be grammatically correct by native Vietnamese speakers. This does not, however, mean that all possible readings of these sentences are found in normal or natural speech. Some of them, though grammatical, are awkward or unusual forms.
7. e. g.  $\left\{ \begin{array}{c} \text{đứa} \\ \text{người} \\ \text{CI} \end{array} \right\} \begin{array}{l} \text{con} \\ \text{child} \end{array}$        $\left\{ \begin{array}{c} \text{cái} \\ \text{con} \\ \text{CI} \end{array} \right\} \begin{array}{l} \text{dao} \\ \text{knife} \end{array}$
8. The verbal complement construction in Vietnamese seems to be distinct from the nominal construction in that the nominal may not occur with đê mà. Furthermore, the noun subject of the verbal complement construction is always shared by the noun subject of the matrix sentence, the noun subject of the factitive construction may or may not be.

REFERENCES:

- Bulteau, R. 1953. Cours d'Annamite. Paris: Larose.
- Cadière, Leopold. 1958. Syntaxe de la langue Vietnamienne. PEFEO 42. Paris.
- Chomsky, Noam. 1965. Aspects of the Theory of Syntax. Cambridge: MIT.
- Emeneau, Murray B. 1951. Studies in Vietnamese (Annamese) Grammar. University of California Publications in Linguistics 8. Berkeley.
- Gage, William W. and H. Merrill Jackson. 1953. Verb Constructions in Vietnamese. Cornell Southeast Asia Program Data Paper No. 9. Ithaca.
- Hòa, Nguyễn Đình. 1957. Classifiers in Vietnamese. Word 13:124-152.
- \_\_\_\_\_. 1963. Speak Vietnamese. Saigon: Min. of Education.
- Honey, P.J: 1956. Word Classes in Vietnamese. BSOAS 18:534-544.
- Liêm, Nguyễn Đăng. 1966. A Contrastive Phonological and Grammatical Study of English and Vietnamese, Part I. Canberra: Australian National University.
- Lý, Lê Văn. 1948. Le Parler Vietnamien. Paris: Hương Anh.
- Pittman, Richard S. 1960. Southeast Asia from the Linguistic Point of View. Đại-học Văn -khoa 1959-60:154-160.
- Thomas, David. 1958.ms. The Preverb Auxiliary System of Vietnamese.
- Thompson, Laurence C. 1965. A Vietnamese Grammar. Seattle: U. Washington.